

Trimmers

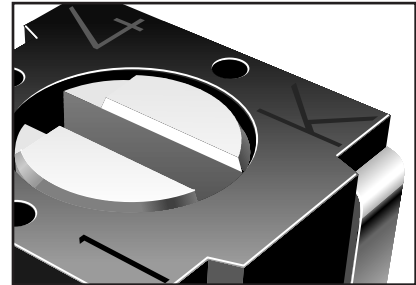

- I. Product Selection Guide6
- II. Product Specifications9
- III. Optional Products.....69
- IV. Tape and Reel Packaging Specifications.....70
- V. Panel Mounting Options.....72
- VI. Adjustment Tools77
- VII. Lab Design Kits77
- VIII. Mil-Spec Part Numbering.....79
- IX. Applications/Processing Guide.....83
- X. Soldering and Cleaning Processes84



SMT Trimmers - Product Selection Guide



| Model Number | Element Technology | | Number of Turns | | Sealed Open | | Size | | | | | Packaging Options | Adjust | Page No. |
|--------------|--------------------|-----|-----------------|-------|-------------|------|------|-----|-----|-----|------|-------------------|------------|----------|
| | Cermet | W/W | Single | Multi | Sealed | Open | 2mm | 3mm | 4mm | 5mm | 1/4" | See Note 1 | See Note 2 | |
| 3214* | • | | | • | • | | | | • | | | E | T,S | 12 |
| 3224* | • | | | • | • | | | | • | | | E | T,S | 14 |
| 3269* | • | | | • | • | | | | | | • | G,T | T,S | 22 |
| 3302 | • | | • | | | • | • | | | | | E | T | 32 |
| 3303 | • | | • | | | • | | • | | | | E | T,B | 34 |
| 3313* | • | | • | | • | | | • | | | | E | T,S | 39 |
| 3314 | • | | • | | • | | | • | | | | E,G,T | T,S | 41 |
| 3324* | • | | • | | • | | | • | | | | E | T | 47 |
| 3364 | • | | • | | | • | | • | | | | E | T,B | 56 |
| 3374* | • | | • | | • | | | • | | | | E | T | 58 |

NOTE 1: Standard packaging; some options may require alternate packaging. Consult factory.
 T = Tube, B = Bulk, E = Embossed Tape - 7" Reel, G = Embossed Tape - 13" Reel

NOTE 2: T = Top Adjustment, S = Side Adjustment, B = Bottom Adjustment

*Indicates patented models.

Commercial/Industrial Through-Hole Sealed

BOURNS®

| Model Number | Element Technology | | Number of Turns | | Size | | | | | | Packaging Options | Adjust | Page No. |
|--------------|--------------------|----|-----------------|-------|----------|-----------|----------|------|------|--------|-------------------|------------|----------|
| | Cermet | WW | Single | Multi | 1/4" Sq. | 5/16" Sq. | 3/8" Sq. | 1/2" | 3/4" | 1-1/4" | See Note 1 | See Note 2 | |
| 3005** | | • | | • | | | | | • | | T | S | 69 |
| 3006 | • | | | • | | | | | • | | T | S | 9 |
| 3009** | • | | | • | | | | | • | | T,B | S | 69 |
| 3057 | | • | | • | | | | | | • | T,B | S | 10 |
| 3059 | • | | | • | | | | | | • | T,B | S | 11 |
| 3082** | • | | | • | | | | • | | | T | S | 69 |
| 3250 | | • | | • | | | | • | | | T,B | T,S | 16 |
| 3252 | • | | | • | | | | • | | | T,B | T,S | 17 |
| 3260 | | • | | • | • | | | | | | T | T,S | 18 |
| 3262* | • | | | • | • | | | | | | T | T,S | 19 |
| 3266* | • | | | • | • | | | | | | T,R | T,S | 20 |
| 3266-LTC | • | | | • | • | | | | | | T | T,S | 21 |
| 3290 | | • | | • | | | • | | | | T,B | T,S | 24 |
| 3292* | • | | | • | | | • | | | | T,B | T,S | 25 |
| 3296* | • | | | • | | | • | | | | T,R | T,S | 26 |
| 3296-LTC | • | | | • | | | • | | | | T | T,S | 27 |
| 3296-LC2* | • | | | • | | | • | | | | T,B | T,S | 29 |
| 3296-OT1* | • | | | • | | | • | | | | T | T,S | 30 |
| 3299* | • | | | • | | | • | | | | T,B | T,S | 31 |
| 3329 | • | | • | | • | | | | | | T,B,R | T,S | 51 |
| 3339 | • | | | • | | • | | | | | T | T,S | 52 |
| 3345** | | • | • | | | | | • | | | B | T,S | 69 |
| 3362 | • | | • | | • | | | | | | T,R | T,S | 54 |
| 3386 | • | | • | | | | • | | | | T,B,R | T,S | 59 |
| 3386-HV2 | • | | • | | | | • | | | | T | T,S | 61 |
| 3386-HV3 | • | | • | | | | • | | | | T | T,S | 61 |
| 3386-OT1 | • | | • | | | | • | | | | T,B | T | 62 |

NOTE 1: Standard packaging; some options may require alternate packaging. Consult factory.
T = Tube, B = Bulk, R = Tape and Reel

NOTE 2: T = Top Adjustment, S = Side Adjustment

*Indicates patented models.

**Optional products (not recommended for new designs).

Specifications are subject to change without notice.

Open Frame Trimmers



| Model Number | Element Technology | | Number of Turns | | Mounting Type | | Size | | | | | | Packaging Options | Adjust | Page No. |
|--------------|--------------------|--------|-----------------|-------|---------------|--------|------|-----|-----|-----|-----|------|-------------------|------------|----------|
| | Cermet | Carbon | Single | Multi | SMT | Leaded | 2mm | 3mm | 4mm | 6mm | 9mm | 3/8" | See Note 1 | See Note 2 | |
| 3302 | • | | • | | • | | • | | | | | | E | T | 32 |
| 3303 | • | | • | | • | | | • | | | | | E | T,B | 34 |
| 3306 | • | | • | | | • | | | • | | | | B | T,S | 36 |
| 3309 | • | | • | | | • | | | | • | | | B | T,S,B | 37 |
| 3318 | | • | • | | | • | | | • | | | | B | T,S | 44 |
| 3319 | | • | • | | | • | | | | • | | | B | T,S,B | 45 |
| 3328 | | • | • | | | • | | | | • | | | B | T,S,B | 49 |
| 3352 | • | | • | | | • | | | | | • | | B | T,S | 53 |
| 3364 | • | | • | | • | | | • | | | | | E | T | 56 |
| TC76 | | • | • | | | • | | | • | | | | B, T&R, A | T,S,B | 65 |

Application Specific Products

| Model Number | Element Technology | | Number of Turns | | Size | | | | | | Packaging Options | Adjust | Page No. | |
|--------------|--------------------|----|-----------------|-------|------|-------|------|------|------|--------|-------------------|------------|----------|----|
| | Cermet | WW | Single | Multi | 1/4" | 5/16" | 3/8" | 1/2" | 3/4" | 1-1/4" | See Note 1 | See Note 2 | | |
| 3266-LTC | • | | | • | • | | | | | | | T | T,S | 21 |
| 3296-LTC | • | | | • | | | • | | | | | T | T,S | 27 |
| 3296-LC2* | • | | | • | | | • | | | | | T | T,S | 29 |
| 3296-OT1* | • | | | • | | | • | | | | | T | T,S | 30 |
| 3386-HV2 | • | | • | | | | • | | | | | T | T,S | 61 |
| 3386-HV3 | • | | • | | | | • | | | | | T | T,S | 61 |
| 3386-OT1* | • | | • | | | | • | | | | | T,B | T | 62 |

Military Products

| Model Number | Element Technology | | Turns | | Size | | | | Packaging Options | Adjust | Page No. |
|--------------|--------------------|-----|--------|-------|------|------|------|--------|-------------------|------------|----------|
| | Cermet | W/W | Single | Multi | 1/4" | 3/8" | 1/2" | 1-1/4" | See Note 1 | See Note 2 | |
| RJ 22 | • | | | • | | | • | | T,B | T,S | 17 |
| RJ/RJR 24* | • | | | • | | • | | | T,B | T,S | 28 |
| RJ/RJR 26 | • | | | • | • | | | | T | T,S | 19 |
| RT/RTR 22 | | • | | • | | | • | | T,B | T,S | 16 |
| RT/RTR 24 | | • | | • | | • | | | T | T,S | 24 |
| RT 26 | | • | | • | • | | | | T | T,S | 18 |

NOTE 1: Standard packaging; some options may require alternate packaging. Consult factory.
 T = Tube, B = Bulk, E = Embossed Tape - 7" Reel, G = Embossed Tape - 13" Reel
 T&R = Tape & Reel, A = Ammo Pak

NOTE 2: T = Top Adjustment, S = Side Adjustment,
 B = Bottom Adjustment

* Indicates patented models.

AVAILABLE THROUGH DISTRIBUTION

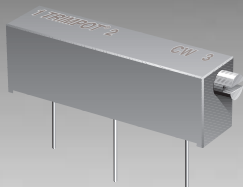

BOURNS®

Features

- 3/4" Rectangular / Multiturn Cermet / Industrial / Sealed
- Low PC board profile - only 1/4" high
- Panel mount option available, (see page 72 for details)

- Transparent housing available, can be set visually without hook-up and instrumentation ("P" style only)

3006 - Trimpot® Trimming Potentiometer

Electrical Characteristics

Standard Resistance Range10 to 5 megohms
 (see standard resistance table)
 Resistance Tolerance±10% std.
 (tighter tolerance available)
 Absolute Minimum Resistance1.0% or 2 ohms max.
 (whichever is greater)
 Contact Resistance Variation1.0% or 1 ohm max.
 (whichever is greater)
 Adjustability
 Voltage±0.01%
 Resistance±0.05%
 ResolutionInfinite
 Insulation Resistance500 vdc.
 1,000 megohms min.

Dielectric Strength
 Sea Level1,000 vac
 80,000 Feet250 vac
 Adjustment Angle15 turns nom.

Environmental Characteristics

Power Rating (400 volts max.)
 70°C0.75 watt
 125°C0 watt
 Temperature Range-55°C to +125°C
 Temperature Coefficient±100ppm/°C
 Seal Test85°C Fluorinert*
 HumidityMIL-STD-202 Method 103
 96 hours
 (3% ΔTR, 20 Megohms IR)
 Vibration20G (2% ΔTR; 2% ΔVR)
 Shock50G (2% ΔTR; 2% ΔVR)
 Load Life1,000 hours 0.75 watt 70°C
 (4% ΔTR)
 Rotational Life200 cycles
 (3% ΔTR; 1% or 1 ohm,
 whichever is greater, CRV)

Physical Characteristics

Torque5.0 oz-in. max.
 Mechanical StopsWiper idles
 TerminalsSolderable pins
 Weight0.04 oz.
 MarkingManufacturer's
 trademark, resistance code,
 terminal numbers, date code,
 manufacturer's model number
 and style
 Wiper Positioning50% nominal
 FlammabilityU.L. 94V-0
 Standard Packaging25 pcs. per tube
 Adjustment ToolH-90

Common Dimensions

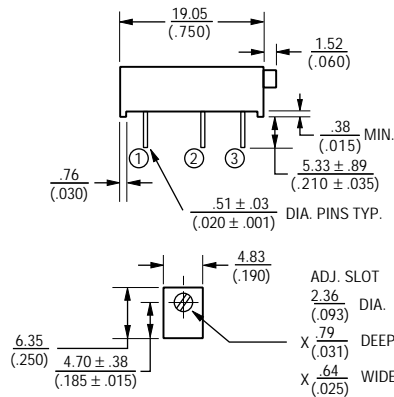

3006P

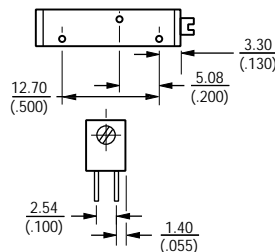

3006W

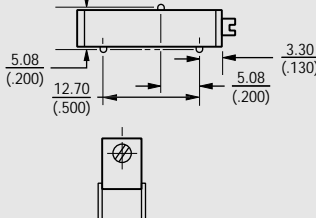

3006Y

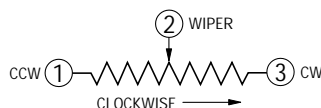
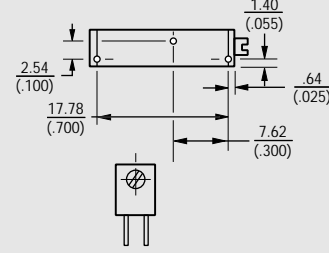

TOLERANCES: ± 0.25 (.010) EXCEPT WHERE NOTED

DIMENSIONS ARE: METRIC / (INCHES)

How To Order

Model **3006 P - 1 - 103 Z**
 Style _____
 Standard or Modified Product Indicator _____
 -1 = Standard Product
 -7 = Transparent Housing
 Resistance Code _____
 Optional Suffix Letter _____
 Z = Panel Mount (Factory Installed)
 Consult factory for other available options.

Standard Resistance Table

| Resistance (Ohms) | Resistance Code |
|-------------------|-----------------|
| 10 | 100 |
| 20 | 200 |
| 50 | 500 |
| 100 | 101 |
| 200 | 201 |
| 500 | 501 |
| 1,000 | 102 |
| 2,000 | 202 |
| 5,000 | 502 |
| 10,000 | 103 |
| 20,000 | 203 |
| 25,000 | 253 |
| 50,000 | 503 |
| 100,000 | 104 |
| 200,000 | 204 |
| 250,000 | 254 |
| 500,000 | 504 |
| 1,000,000 | 105 |
| 2,000,000 | 205 |

Popular values listed in boldface. Special resistances available.

SHADED AREAS TYPICALLY NOT STOCKED BY DISTRIBUTORS AND NOT RECOMMENDED FOR NEW DESIGNS.

*"FLUORINERT" IS A REGISTERED TRADEMARK OF 3M CO.

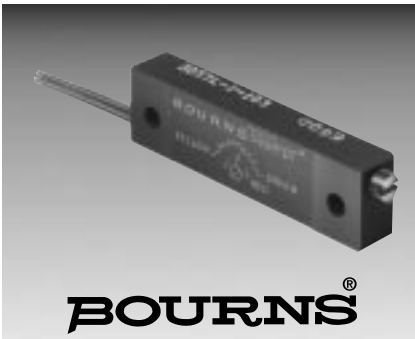

Features

- 1-1/4" Rectangular / Multiturn
Wirewound / Industrial / Sealed
- Panel mount option available
(see page 72 for details)

3057 - Trimpot® Trimming Potentiometer

Electrical Characteristics

Standard Resistance Range10 to 50K ohms
(see standard resistance table)
Resistance Tolerance±5% std.
(tighter tolerance available)
Absolute Minimum Resistance0.1% or 1 ohm max.
(whichever is greater)
Noise100 ohms ENR max.
ResolutionSee Resistance Table
Insulation Resistance500 vdc.
1,000 megohms min.
Dielectric Strength
Sea Level1,500 vac
70,000 Feet400 vac
Adjustment Travel22 turns nom.

Environmental Characteristics

Power Rating @ 70°C1 watt
Power Rating @ 150°C0 watt
Temperature Range-55°C to +150°C
Temperature Coefficient±50ppm/°C
Seal Test85°C Fluorinert*
(pin styles only)
HumidityMIL-STD-202 Method 106
96 hours
2% ΔTR, 100 Megohms IR)
Vibration30G (1% ΔTR; 0.5%
+ resolution ΔVR)
Shock100G (1% ΔTR; 0.5%
+ resolution ΔVR)
Load Life1,000 hours 1 watt @ 70°C
(2% ΔTR)
Rotational Life200 cycles (2% ΔTR)

Physical Characteristics

Torque5.0 oz-in. max.
Mechanical StopsWiper idles
TerminalsSolderable pins and lugs
Flexible leads(7 strands of 30 AWG)
Weight0.10 oz.
MarkingManufacturer's trademark,
resistance code, terminal numbers,
date code, manufacturer's model
number and style
WiperSet at CW end
FlammabilityU.L. 94V-0
Standard Packaging
P&Y Style10 pcs. per tube
L&J Style25 pcs. per bag
Adjustment ToolH-90

*"FLUORINERT" IS A REGISTERED TRADEMARK OF 3M CO.

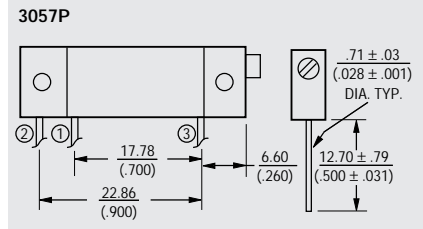
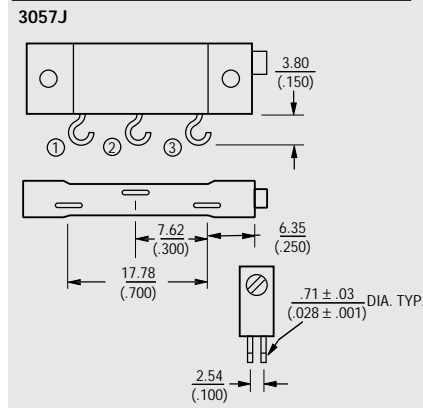
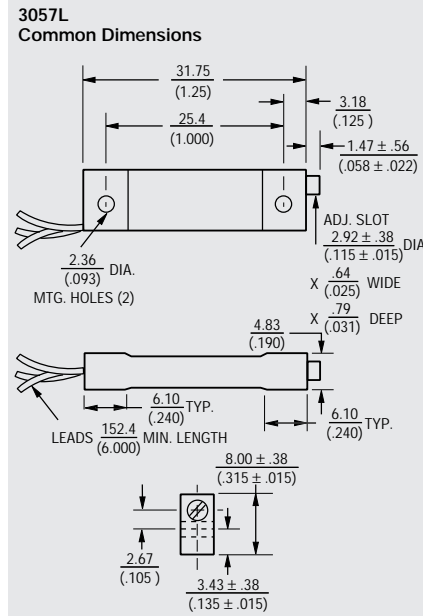

How To Order

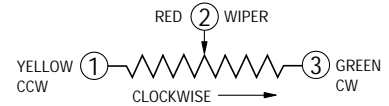
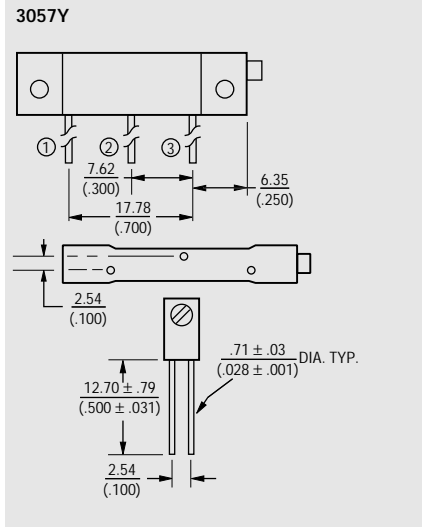
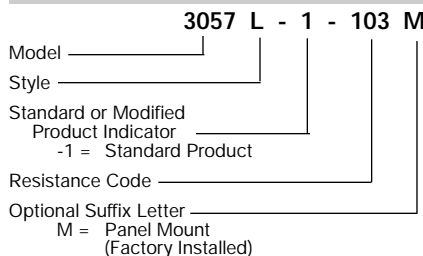

TOLERANCES: ± 0.25 (.010) EXCEPT WHERE NOTED

DIMENSIONS ARE: METRIC (INCHES)

Standard Resistance Table

| Resistance (Ohms) | Resistance Code | Nominal Resolution (Percent) |
|-------------------|-----------------|------------------------------|
| 10 | 100 | 2.40 |
| 20 | 200 | 1.90 |
| 50 | 500 | 1.40 |
| 100 | 101 | 1.00 |
| 200 | 201 | 0.86 |
| 500 | 501 | 0.89 |
| 1,000 | 102 | 0.72 |
| 2,000 | 202 | 0.58 |
| 5,000 | 502 | 0.43 |
| 10,000 | 103 | 0.34 |
| 20,000 | 203 | 0.31 |
| 50,000 | 503 | 0.24 |

Popular values listed in boldface. Special resistances available.

SHADED AREAS TYPICALLY NOT STOCKED BY DISTRIBUTORS AND NOT RECOMMENDED FOR NEW DESIGNS.

Specifications are subject to change without notice.

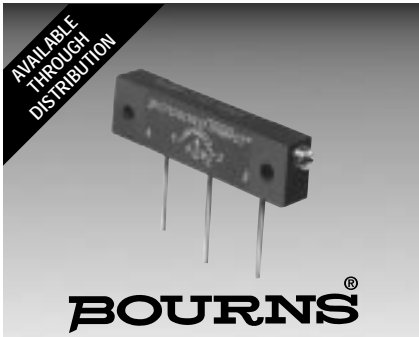

Features

- 1-1/4" Rectangular / Multiturn Cermet / Industrial / Sealed
- Panel mount option available (see page 72 for details)

3059 - Trimpot® Trimming Potentiometer

Electrical Characteristics

Standard Resistance Range10 to 2 megohms (see standard resistance table)
 Resistance Tolerance±10% std. (tighter tolerance available)
 Absolute Minimum Resistance1% or 2 ohms max. (whichever is greater)
 Contact Resistance Variation1.0% or 1 ohm max. (whichever is greater)
 Adjustability
 Voltage±0.01%
 Resistance±0.05%
 ResolutionInfinite
 Insulation Resistance500 vdc. 1,000 megohms min.
 Dielectric Strength
 Sea Level900 vac
 70,000 Feet350 vac
 Effective Travel22 turns nom.

Environmental Characteristics

Power Rating @ 70°C (400 volts max.)1.0 watt
 Power Rating @ 150°C0 watt
 Temperature Range-55°C to +150°C
 Temperature Coefficient±100ppm/°C
 Seal Test85°C Fluorinert* (pin styles only)
 HumidityMIL-STD-202 Method 106 (2% ΔTR, 10 Megohms IR)
 Vibration20G (1% ΔTR; 1% ΔVR)
 Shock50G (1% ΔTR; 1% ΔVR)
 Load Life ..1,000 hours 1.0 watt @ 70°C (3% ΔTR; 1% or 1 ohms, whichever is greater, CRV)
 Rotational Life200 cycles (2% ΔTR; 1% or 1 ohm, whichever is greater, CRV)

Physical Characteristics

Torque5.0 oz-in. max.
 Mechanical StopsWiper idles
 Terminals. Solderable printed circuit pins
 Flexible leads(7 strands of 30 AWG)
 Weight0.1 oz.
 MarkingManufacturer's trademark,resistance code, terminalnumbers, date code, manufacturer's model number and style
 WiperSet at CW end
 FlammabilityU.L. 94V-0
 Standard Packaging
 P&Y Styles10 pcs. per tube
 L&J Styles25 pcs. per bag
 Adjustment ToolH-90

*"FLUORINERT" IS A REGISTERED TRADEMARK OF 3M CO.

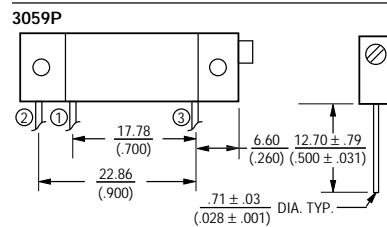
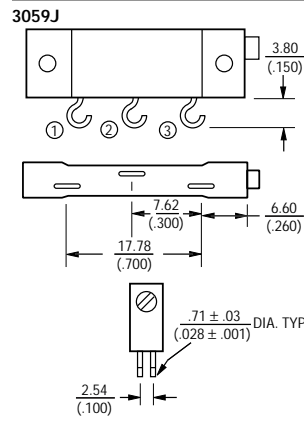
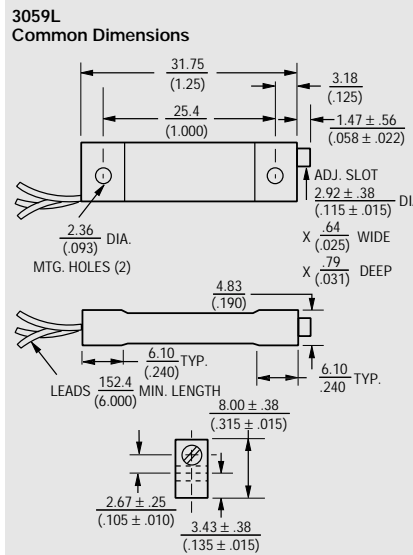

How To Order

Model **3059 L - 1 - 103 M**
 Style _____
 Standard or Modified Product Indicator _____
 -1 = Standard Product
 Resistance Code _____
 Optional Suffix Letter _____
 M = Panel Mount (Factory Installed)

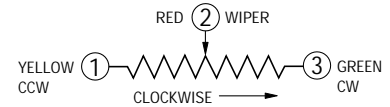
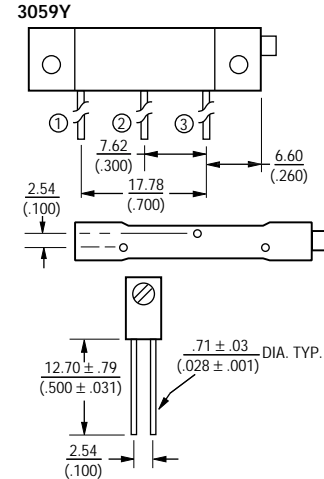

TOLERANCES: ± 0.25 (.010) EXCEPT WHERE NOTED

DIMENSIONS ARE: METRIC (INCHES)

Standard Resistance Table

| Resistance (Ohms) | Resistance Code |
|-------------------|-----------------|
| 10 | 100 |
| 20 | 200 |
| 50 | 500 |
| 100 | 101 |
| 200 | 201 |
| 500 | 501 |
| 1,000 | 102 |
| 2,000 | 202 |
| 5,000 | 502 |
| 10,000 | 103 |
| 20,000 | 203 |
| 25,000 | 253 |
| 50,000 | 503 |
| 100,000 | 104 |
| 200,000 | 204 |
| 250,000 | 254 |
| 500,000 | 504 |
| 1,000,000 | 105 |
| 2,000,000 | 205 |

Popular values listed in boldface. Special resistances available.

SHADED AREAS TYPICALLY NOT STOCKED BY DISTRIBUTORS AND NOT RECOMMENDED FOR NEW DESIGNS.



Features

- Surface Mount 4mm Square / Multiturn Cermet / Industrial / Sealed
- Sealed to withstand board wash processing
- Pick and place centering design, with flush adjustment

- 4mm design meets EIA/EIAJ/IPC/VRCI SMD standard trimmer footprint
- Top and side adjust styles
- J-hook, and gull-wing
- Patent #5047746 advanced drive/wiper mechanism

3214 - 5-Turn Trimming Potentiometer

Electrical Characteristics

Standard Resistance Range 10 to 2 megohm
 (see standard resistance table)
 Resistance Tolerance ±10% std.
 Absolute Minimum Resistance 1% or 2.0 ohms
 (whichever is greater)
 Contact Resistance Variation 3% or 3 ohms max.
 Resolution Essentially Infinite
 Insulation Resistance 500 vdc.
 100 megohms min.
 Dielectric Strength
 Sea Level 600 vac (1minute)
 Adjustment Angle 5 turns nom.

Environmental Characteristics

Power Rating (300 volts max.)
 85°C 0.25 watt
 150°C 0 watt
 Temperature Range -65°C to +150°C
 Temperature Coefficient ±100ppm/°C
 Humidity MIL-STD 202 Method 106
 TRS ±2%; IR 10 megohms
 Vibration 20G TRS ±1%; VRS ±1%
 Shock 100G TRS ±1%; VRS ±1%
 Load Life
 @ 85°C rated power 1,000 hours
 TRS 3 ohms or 3%
 (whichever is greater)
 Rotational Cycling 200 cycles
 TRS 3 ohms or 3%
 (whichever is greater)
 Thermal Shock 5 cycles
 TRS ±2%; VRS ±1%

Physical Characteristics

Mechanical Stop Wiper idles
 Torque 180g-cm max.
 Weight Approximately 0.01 oz.
 Marking Manufacturer's code,
 resistance code and date code
 Solderability Per MIL-STD-202,
 Method 208
 Wiper Set at 50% nominal
 Flammability UL94V0
 Pushover Strength .. 2 Kilograms (4.4lbs)
 Adjustment Tool H-91

3214G Side Adjust

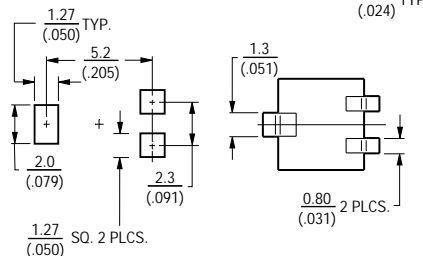
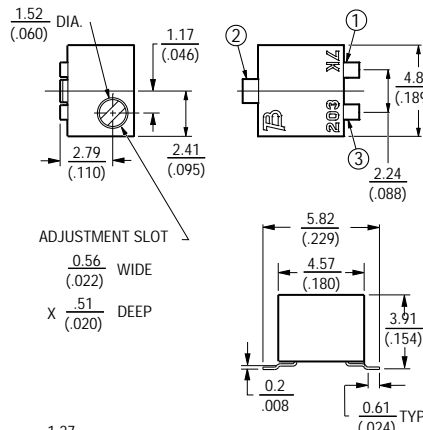

3214J Side Adjust

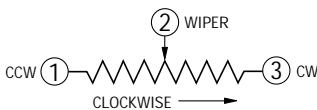
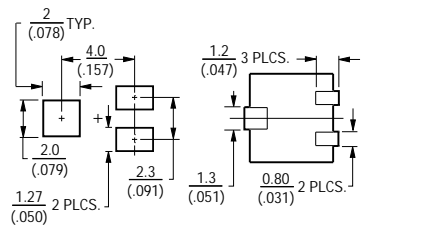
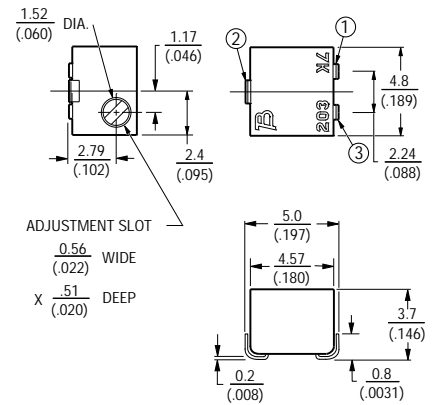

TOLERANCES: ± 0.25 (.010) EXCEPT WHERE NOTED

DIMENSIONS ARE: $\frac{\text{METRIC}}{\text{(INCHES)}}$

How To Order

3214 J - 1 - 502 E

Model _____
 Style _____
 Standard or Modified Product Indicator
 -1 = Standard Product - IR Reflow
 * -2 = Wave Solderable
 Resistance Code _____
 Embossed Tape Designator _____
 Style J, G: 500 pcs./7" reel (standard)
 Style W: 250 pcs./7" reel (standard)

Consult factory for other available options.
 * -2 has a treated stainless steel shaft

3214W Top Adjust

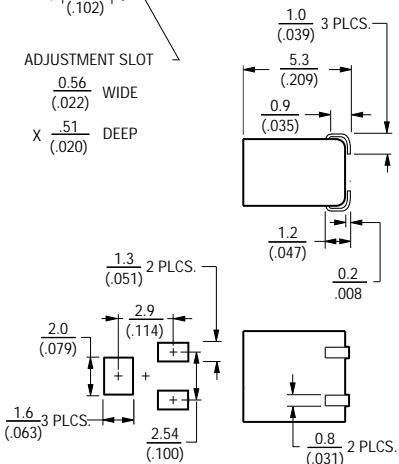
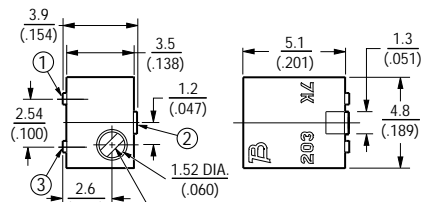

3214 - Packaging Specifications



Packaging Specifications (J & G Styles)

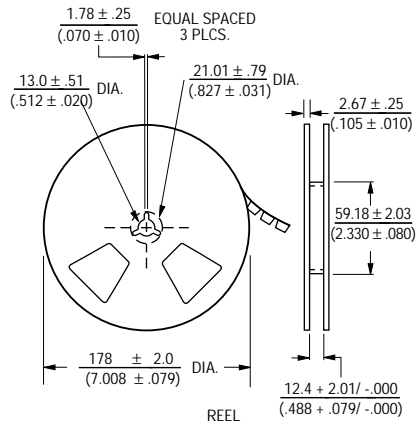
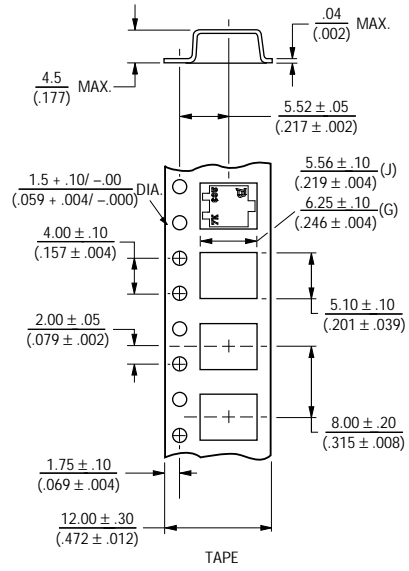

Cover tape peel strength:
Meets EIA specification 481.

Units packaged 500 pieces per reel.

Packaging Specifications (W Style)

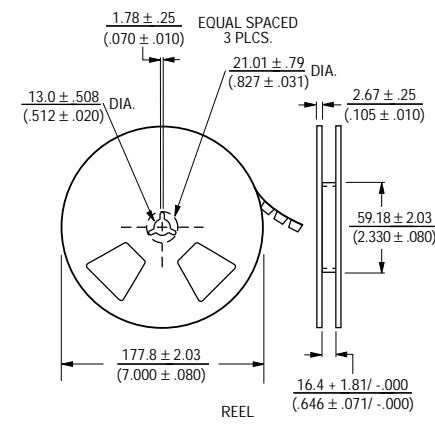
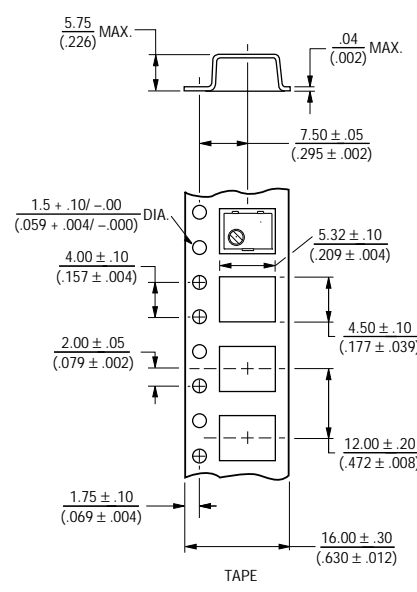

Cover tape peel strength:
Meets EIA specification 481.

Units packaged 250 pieces per reel.

Standard Resistance Table

| Resistance (Ohms) | Resistance Code |
|-------------------|-----------------|
| 10 | 100 |
| 20 | 200 |
| 50 | 500 |
| 100 | 101 |
| 200 | 201 |
| 500 | 501 |
| 1,000 | 102 |
| 2,000 | 202 |
| 5,000 | 502 |
| 10,000 | 103 |
| 20,000 | 203 |
| 50,000 | 503 |
| 100,000 | 104 |
| 200,000 | 204 |
| 500,000 | 504 |
| 1,000,000 | 105 |
| 2,000,000 | 205 |

Popular values listed in boldface. Special resistances available.

SHADED AREAS TYPICALLY NOT STOCKED BY DISTRIBUTORS AND NOT RECOMMENDED FOR NEW DESIGNS.



Features

- Surface Mount 4mm Square / Multiturn Cermet / Industrial / Sealed
- Sealed to withstand board wash processing
- Pick and place centering design, with flush adjustment

- 4mm design meets EIA/EIAJ/IPC/VRCI SMD standard trimmer footprint
- Low CRV - 1%
- DESC selected material drawing #92021

3224 - 4mm SMD Trimming Potentiometer

Electrical Characteristics

Standard Resistance Range 10 to 2 megohm
 (see standard resistance table)
 Resistance Tolerance ±10% std.
 Absolute Minimum Resistance 1% or 2.0 ohms
 (whichever is greater)
 Contact Resistance Variation 1% or 3 ohms max.
 Resolution Essentially Infinite
 Insulation Resistance 500 vdc.
 100 megohms min.
 Dielectric Strength
 Sea Level 600 vac (1minute)
 Adjustment Angle 11 turns nom.

Environmental Characteristics

Power Rating (300 volts max.)
 85°C 0.25 watt
 150°C 0 watt
 Temperature Range -65°C to +150°C
 Temperature Coefficient ±100ppm/°C
 Humidity MIL-STD 202 Method 106
 TRS ±2%; IR 10 megohms
 Vibration 20G TRS ±1%; VRS ±1%
 Shock 100G TRS ±1%; VRS ±1%
 Load Life
 @ 85°C rated power 1,000 hours
 TRS 3 ohms or 3% (whichever is greater)
 Rotational Cycling 200 cycles
 TRS 3 ohms or 3% (whichever is greater)
 Thermal Shock 5 cycles
 TRS ±2%; VRS ±1%

Physical Characteristics

Mechanical Stop Wiper idles
 Torque 180g-cm max.
 Weight Approximately 0.01 oz.
 Marking Manufacturer's code, resistance code and date code
 Solderability Per MIL-STD-202, Method 208
 Wiper Set at 50% nominal
 Flammability UL94V0
 Adjustment Tool H-91

How To Order

3224 J - 1 - 502 E

Model _____
 Style _____
 Standard or Modified Product Indicator
 -1 = Standard Product - IR Reflow
 * -2 = Wave Solderable
 -FW5 = .070" ± .010" Shaft Extension
 Resistance Code _____
 Embossed Tape Designator _____
 Style J, G: 500 pcs./7" reel (standard)
 Style W: 250 pcs./7" reel (standard)
 Consult factory for other available options.
 * -2 has a treated stainless steel shaft

3224J Side Adjust

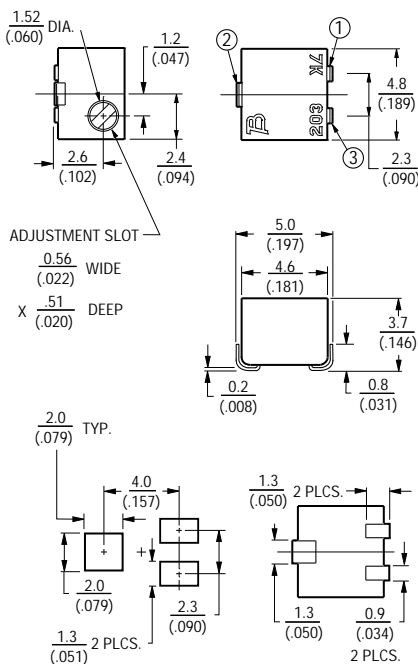

3224G Side Adjust

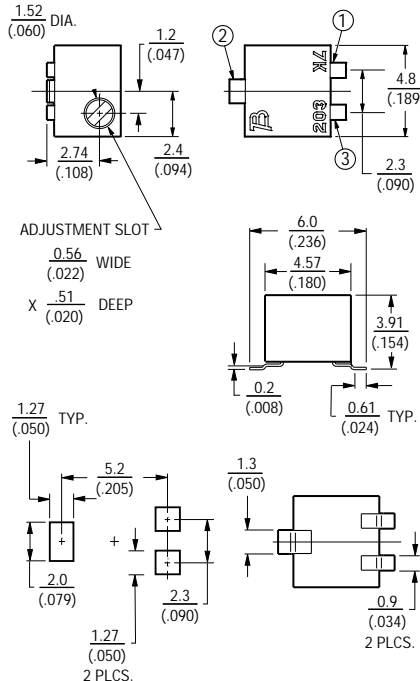

3224W Top Adjust

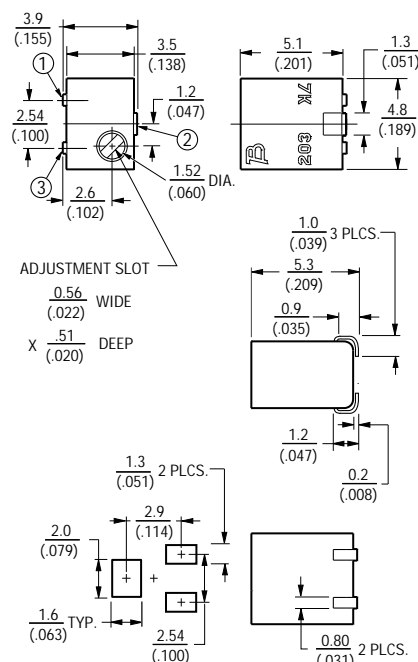

3224X Top Adjust

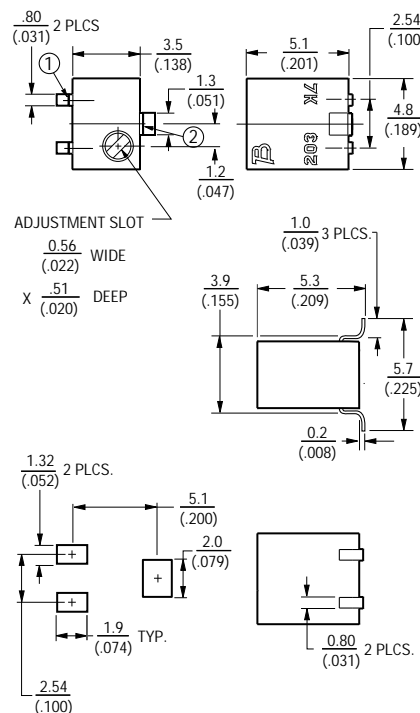

Additional Features

- Top and side adjust styles
- J-hook, and gull-wing
- Patent #5047746 advanced drive/wiper mechanism

3224 - Packaging Specifications

BOURNS®

J & G Styles

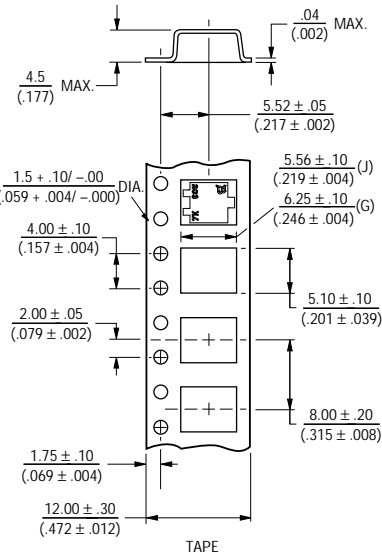

W Style

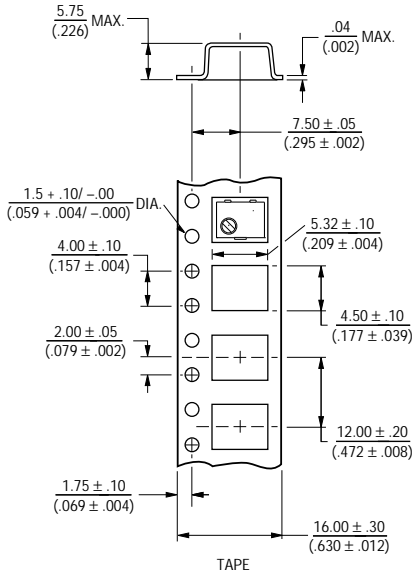

X Style

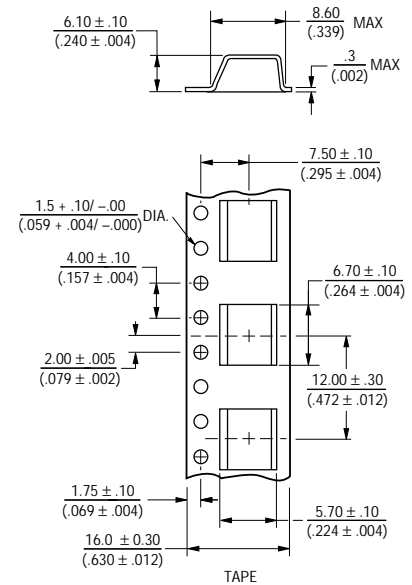

W & X Style Reel

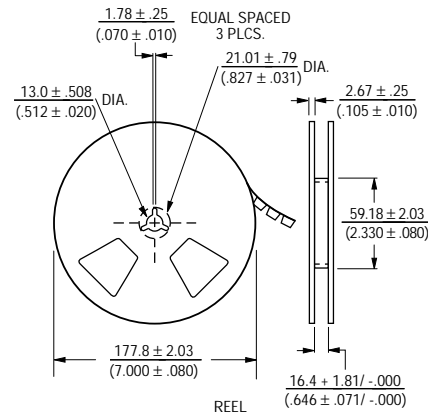
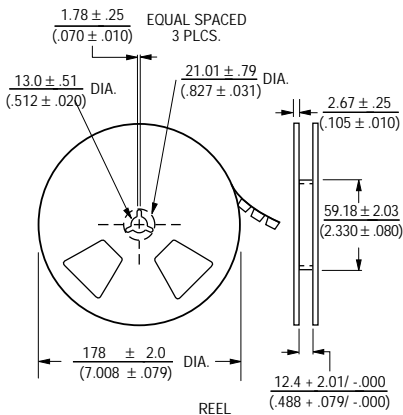

Cover tape peel strength:
Meets EIA specification 481.

Cover tape peel strength:
Meets EIA specification 481.

Units packaged 500 pieces per reel.

Units packaged 250 pieces per reel. (w)
Units packaged 200 pieces per reel. (x)

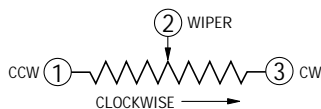

TOLERANCES: ± 0.25 (.010) EXCEPT WHERE NOTED

DIMENSIONS ARE: METRIC / (INCHES)

Standard Resistance Table

| Resistance (Ohms) | Resistance Code |
|-------------------|-----------------|
| 10 | 100 |
| 20 | 200 |
| 50 | 500 |
| 100 | 101 |
| 200 | 201 |
| 500 | 501 |
| 1,000 | 102 |
| 2,000 | 202 |
| 5,000 | 502 |
| 10,000 | 103 |
| 20,000 | 203 |
| 50,000 | 503 |
| 100,000 | 104 |
| 200,000 | 204 |
| 500,000 | 504 |
| 1,000,000 | 105 |
| 2,000,000 | 205 |

Popular values listed in boldface. Special resistances available.

SHADED AREAS TYPICALLY NOT STOCKED BY DISTRIBUTORS AND NOT RECOMMENDED FOR NEW DESIGNS.

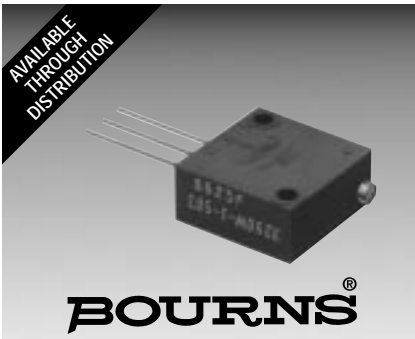

Features

- Multiturn / Wirewound / Sealed
- Listed on the QPL for style RT22 per MIL-R-27208 and RTR22 per High-Rel MIL-R-39015
- Panel Mount option available (see page 73 for details)

3250/RT22/RTR22 - 1/2" Square Trimming Potentiometer

Electrical Characteristics

Standard Resistance Range
 3250 10 to 50K ohms
 RT22 50 to 20K ohms
 RTR22 500 to 20K ohms
 (see standard resistance table)
 Resistance Tolerance ±5% std.
 (tighter tolerance available)
 Absolute Minimum Resistance
 0.1% or 1 ohm max. (whichever is greater)
 Noise 100 ohms ENR max.
 Resolution See Resistance Table
 Insulation Resistance 500 vdc.
 1,000 megohms min.
 Dielectric Strength
 Sea Level 1,000 vac
 80,000 Feet 400 vac
 Adjustment Travel 25 turns nom.

Environmental Characteristics

Power Rating @ 85°C
 3250 1.0 watt
 RT22/RTR22 0.75 watt
 Power Rating @ 150°C 0 watt
 Temperature Range -65°C to +150°C
 Temperature Coefficient
 3250 ±50ppm/°C
 RT22/RTR22 ±50ppm/°C
 Seal Test 85°C Fluorinert® (pin styles only)
 Humidity MIL-STD-202 Method 106
 3250 (2% ΔTR; 100 Megohms IR)
 RT22 (1% ΔTR; 10 Megohms IR)
 RTR22 (1% ΔTR; 100 Megohms IR)
 Vibration 30G
 (1% ΔTR; 0.5% + resolution ΔVR)
 Shock 100G
 (1% ΔTR; 0.5% + resolution ΔVR)
 Load Life
 3250 1,000 hours 1.0 watt @ 85°C
 (2% ΔTR; 500 ohms ENR)
 RT22 1,000 hours 0.75 watt @ 85°C
 (2% ΔTR; 2% + resolution ΔVR)
 RTR22 10,000 hours 0.75 watt @ 85°C
 (3% ΔTR; 2% + resolution ΔTR)
 Rotational Life 200 cycles
 3250 (2% ΔTR; 500 ohms ENR)
 RT22/RTR22 (2% ΔTR)

Physical Characteristics

Torque 5.0 oz-in. max.
 Mechanical Stops Wiper idles
 Terminals
 3250 Solderable printed circuit pins
 Flexible leads (7 strands of 30 AWG)
 RT22/RTR22 MIL-STD-202; Method 208
 Weight 0.06 oz.
 Machine Screw Mounting
 Torque 12 oz-in. max.
 Marking
 3250 Manufacturer's trademark,
 resistance code, terminal numbers,
 date code, manufacturer's model
 number and style
 RT22/RTR22 Mil-spec part number
 Wiper Set at CW end
 Flammability U.L. 94V-0
 Standard Packaging
 P&W Styles 25 pcs. per tube
 L Style 25 pcs. per bag
 Adjustment Tool H-90

3250P/RT22/RTR22 Common Dimensions (Pin Styles)

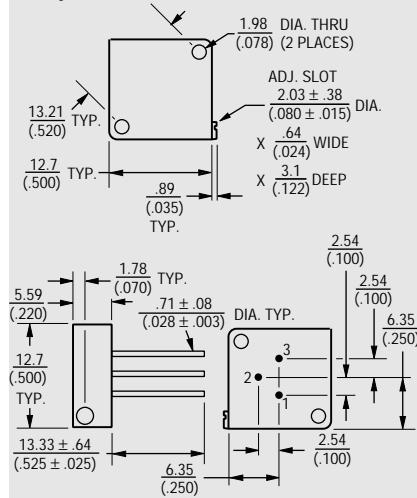

3250W/RT22/RTR22

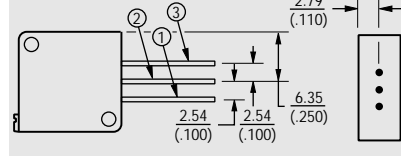

3250W-66/RT22X/RTR22X

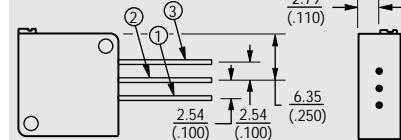

"L" Flex Lead Type

RT22 has mounting slots
 RTR22 has mounting holes

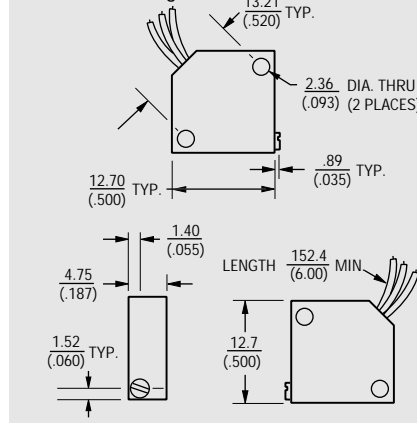

TOLERANCES: ± 0.25 (.010) EXCEPT WHERE NOTED

DIMENSIONS ARE: METRIC / (INCHES)

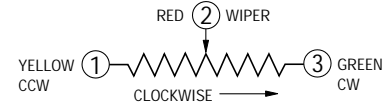

How To Order

3250 L - 1 - 103 M

Model _____
 Style _____
 Standard or Modified Product Indicator _____
 -1 = Standard Product
 Resistance Code _____
 Optional Suffix Letter _____
 M = Panel Mount (Factory Installed)

See page 80 for RT22/RTR22 ordering information.

Consult factory for other available options.

Standard Resistance Table

| Resistance (Ohms) | Nominal Resistance Code | Resolution (Percent) |
|-------------------|-------------------------|----------------------|
| 10 | 100 | 1.30 |
| 20 | 200 | 1.00 |
| 50 | 500 | 0.80 |
| 100 | 101 | 0.90 |
| 200 | 201 | 0.70 |
| 500 | 501 | 0.60 |
| 1,000 | 102 | 0.40 |
| 2,000 | 202 | 0.30 |
| 5,000 | 502 | 0.25 |
| 10,000 | 103 | 0.19 |
| 20,000 | 203 | 0.16 |
| 25,000 | 253 | 0.14 |
| 50,000 | 503 | 0.13 |

Popular values listed in boldface. Special resistances available.

SHADED AREAS TYPICALLY NOT STOCKED BY DISTRIBUTORS AND NOT RECOMMENDED FOR NEW DESIGNS.

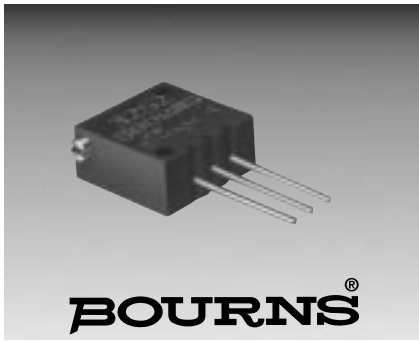

Features

- Multiturn / Cermet / Sealed
- Listed on the QPL for style RJ22 per MIL-R-22097
- Panel mount option available (see page 73 for details)

3252/RJ22 - 1/2" Square Trimming Potentiometer

Electrical Characteristics

Standard Resistance Range
 3252 10 to 2 megohms
 RJ22 10 to 1 megohm
 (see standard resistance table)
 Resistance Tolerance ±10% std.
 (tighter tolerance available)
 Absolute Minimum Resistance
 3252 1% or 2 ohms max.
 (whichever is greater)
 RJ22 1 ohm max.
 Contact Resistance Variation
 3252 1% or 2 ohms max.
 (whichever is greater)
 RJ22 2% or 2 ohms max.
 (whichever is greater)
 Adjustability
 Voltage ±0.01%
 Resistance ±0.05%
 Resolution Infinite
 Insulation Resistance 500 vdc.
 1,000 megohms min.
 Dielectric Strength
 Sea Level 1,000 vac
 80,000 Feet 400 vac
 Effective Travel 25 turns nom.

Environmental Characteristics

Power Rating @ 85°C (400 volts max.)
 3252 0.75 watt
 RJ22 0.50 watt
 Power Rating @ 150°C 0 watt
 Temperature Range -65°C to +150°C
 Temperature Coefficient ±100ppm/°C
 Seal Test 85°C Fluorinert*
 (pin styles only)
 Humidity
 3252 MIL-STD-202 Method 103;
 96 hours (1% ΔTR; 100 Megohms IR)
 RJ22 MIL-STD-202 Method 106
 (1% ΔTR; 10 Megohms IR)
 Vibration
 3252 30G (1% ΔTR; 1% ΔVR)
 RJ22 20G (1% ΔTR; 1% ΔVR)
 Shock 100G (1% ΔTR; 1% ΔVR)
 Load Life
 3252 1,000 hours 0.75 watt @ 85°C
 (3% ΔTR; 3% or 3 ohms,
 whichever is greater, CRV)
 RJ22 1,000 hours 0.5 watt @ 85°C
 (2% ΔTR; 1% ΔVR)
 Rotational Life 200 cycles
 3252 (2% ΔTR; 3% or 3 ohms,
 whichever is greater, CRV)
 RJ22 2% ΔTR

Physical Characteristics

Torque 5.0 oz-in. max.
 Mechanical Stops Wiper idles
 Terminals
 3252 Solderable printed circuit pins
 RJ22 MIL-STD-202; Method 208
 Flexible leads (7 strands of 30 AWG)
 Weight 0.065 oz.
 Wiper Set at CW end
 Flammability U.L. 94V-0

Machine Screw Mounting

Torque 12 oz-in. max.
 Marking
 3252 Manufacturer's trademark,
 resistance code, wiring diagram,
 date code, manufacturer's model
 number and style
 RJ22 Mil-spec part number
 Standard Packaging
 X, P&W Styles 25 pcs. per tube
 L Style 25 pcs. per bag
 Adjustment Tool H-90

How To Order

3252 L - 1 - 103 M

Model _____
 Style _____
 Standard or Modified
 Product Indicator _____
 -1 = Standard Product
 Resistance Code _____
 Optional Suffix Letter _____
 M = Panel Mount (Factory Installed)

See page 81 for RJ22 ordering information.
 Consult factory for other available options.

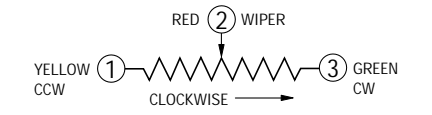
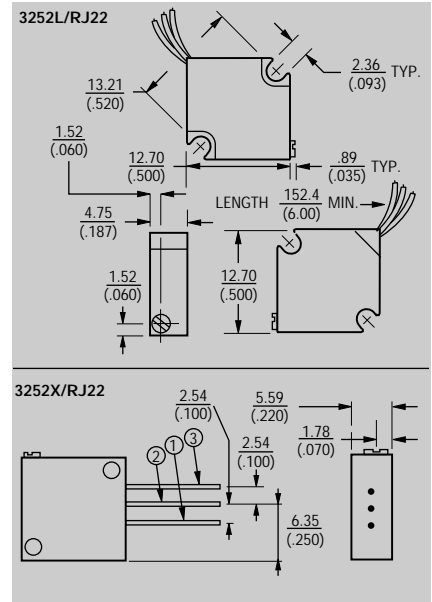
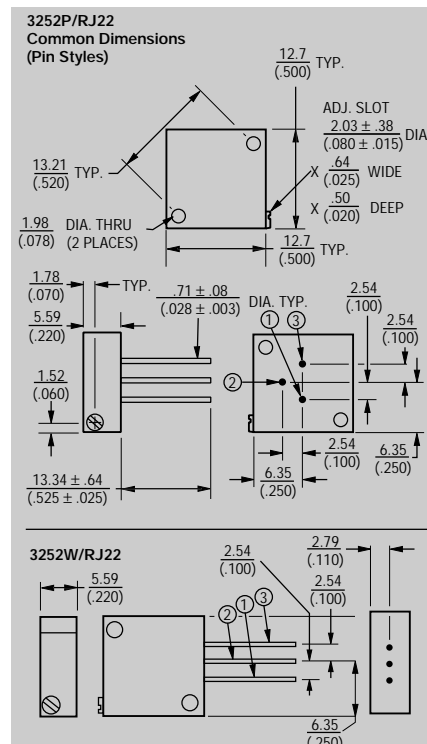

TOLERANCES: ± 0.25 (.010) EXCEPT WHERE NOTED
 DIMENSIONS ARE: METRIC / (INCHES)

Standard Resistance Table

| Resistance (Ohms) | Resistance Code |
|-------------------|-----------------|
| 10 | 100 |
| 20 | 200 |
| 50 | 500 |
| 100 | 101 |
| 200 | 201 |
| 500 | 501 |
| 1,000 | 102 |
| 2,000 | 202 |
| 5,000 | 502 |
| 10,000 | 103 |
| 20,000 | 203 |
| 25,000 | 253 |
| 50,000 | 503 |
| 100,000 | 104 |
| 200,000 | 204 |
| 500,000 | 504 |
| 1,000,000 | 105 |
| 2,000,000 | 205 |

Popular values listed in boldface. Special resistances available.
 SHADED AREAS TYPICALLY NOT STOCKED BY DISTRIBUTORS AND NOT RECOMMENDED FOR NEW DESIGNS.

**FLUORINERT® IS A REGISTERED TRADEMARK OF 3M CO.

AVAILABLE THROUGH DISTRIBUTION

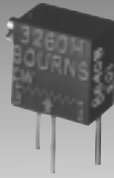

BOURNS[®]

Features

- Multiturn / Wirewound / Industrial / Sealed
- Listed on the QPL for style RT26 per MIL-R-27208

3260/RT26 - 1/4" Square Trimming Potentiometer

Electrical Characteristics

Standard Resistance Range
 3260 10 to 25K ohms
 RT26 10 to 5K ohms
 (see standard resistance table)
 Resistance Tolerance ±5% std.
 (tighter tolerance available)
 Absolute Minimum Resistance
 3260 0.1% or 1 ohm max.
 (whichever is greater)
 RT26 0.25% or 1 ohm max.
 (whichever is greater)
 Noise 100 ohms ENR max.
 Resolution See resistance table
 Insulation Resistance 500 vdc.
 1,000 megohms min.
 Dielectric Strength
 Sea Level 600 vac
 80,000 Feet 250 vac
 Adjustment Angle 11 turns nom.

Environmental Characteristics

Power Rating
 85°C 0.25 watt
 150°C 0 watt
 Temperature Range
 3260 -65°C to +150°C
 RT26 -55°C to +150°C
 Temperature Coefficient
 3260 ±70ppm/°C
 RT26 ±50ppm/°C
 Seal Test 85°C Fluorinert*
 Humidity MIL-STD-202 Method 106
 3260 (2% ΔTR, 100 Megohms IR)
 RT26 (1% ΔTR, 10 Megohms IR)
 Vibration
 326030G (1% ΔTR; 1%
 + resolution ΔVR)
 RT2620G (1% ΔTR; 1%
 + resolution ΔVR)
 Shock 100G
 (1% ΔTR; 1% + resolution ΔVR)
 Load Life 1,000 hours 0.25 watt @ 85°C
 3260 (2% ΔTR; 500 ohms ENR)
 RT26 (2% ΔTR; 2% + resolution ΔVR)
 Rotational Life 200 cycles
 3260 (2% ΔTR; 500 ohms ENR)
 RT26 (2% ΔTR)

Physical Characteristics

Torque 3.0 oz-in. max.
 Mechanical Stops Wiper idles
 Terminals
 3260 Solderable printed circuit pins
 RT26 MIL-STD-202; Method 208
 Weight 0.015 oz.
 Marking
 3260 Manufacturer's trademark,
 resistance code, wiring diagram,
 date code, manufacturer's model
 number and style
 RT26 Mil-spec part number
 Wiper Set at CW end
 Flammability UL 94V-0
 Standard Packaging 50 pcs. per tube
 Adjustment Tool H-90

How To Order

Model 3260 H - 1 - 502
 Style _____
 Standard or Modified Product Indicator _____
 -1 = Standard Product
 Resistance Code _____
 See page 81 for RT26 ordering information.
 Consult factory for other available options.

3260H/RT26 "X" Style Common Dimensions

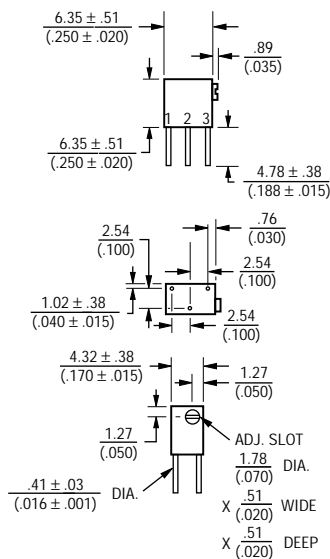

3260W/RT26

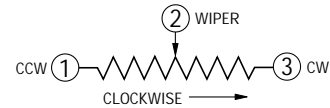
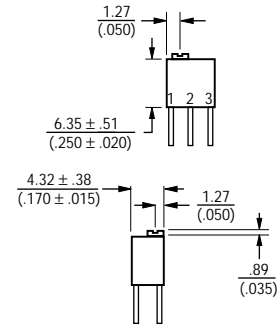

TOLERANCES: ± 0.25 (.010) EXCEPT WHERE NOTED

DIMENSIONS ARE: METRIC (INCHES)

Standard Resistance Table

| Resistance (Ohms) | Resistance Code | Nominal Resolution (Percent) |
|-------------------|-----------------|------------------------------|
| 10 | 100 | 1.90 |
| 20 | 200 | 1.50 |
| 50 | 500 | 1.23 |
| 100 | 101 | 1.00 |
| 200 | 201 | 0.94 |
| 500 | 501 | 0.58 |
| 1,000 | 102 | 0.50 |
| 2,000 | 202 | 0.45 |
| 5,000 | 502 | 0.34 |
| 10,000 | 103 | 0.29 |
| 20,000 | 203 | 0.28 |
| 25,000 | 253 | 0.23 |

Popular values listed in boldface. Special resistances available.

SHADED AREAS TYPICALLY NOT STOCKED BY DISTRIBUTORS AND NOT RECOMMENDED FOR NEW DESIGNS.

FLUORINERT IS A REGISTERED TRADEMARK OF 3M CO.

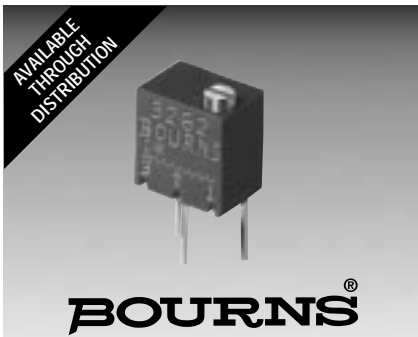

Features

- Multiturn / Cermet / Industrial / Sealed
- Listed on the QPL for style RJ26 per MIL-R-22097 and RJR26 per High-Rel MIL-R-39035
- Patent #4427966 drive mechanism

3262/RJ26/RJR26 - 1/4" Trimming Potentiometer

Electrical Characteristics

Standard Resistance Range10 to 1 megohm
 (see standard resistance table)
 Resistance Tolerance±10% std.
 (tighter tolerance available)
 Absolute Minimum Resistance1% or
 2 ohms max. (whichever is greater)
 Contact Resistance Variation3.0% or
 3 ohms max. (whichever is greater)
 Adjustability
 Voltage±0.02%
 Resistance±0.05%
 ResolutionInfinite
 Insulation Resistance500 vdc.
 1,000 megohms min.
 Dielectric Strength
 Sea Level600 vac
 80,000 Feet250 vac
 Effective Travel12 turns nom.

Environmental Characteristics

Power Rating
 (3262 300 volts max.;
 RJ26/RJR26 200 volts max.)
 85°C0.25 watt
 150°C0 watt
 Temperature Range-65°C to +150°C
 Temperature Coefficient±100ppm/°C
 Seal Test85°C Fluorinert*
 Humidity
 3262MIL-STD-202 Method 103
 96 hours (2% ΔTR, 100 Megohms IR)
 RJ26MIL-STD-202 Method 106
 96 hours (1% ΔTR, 10 Megohms IR)
 RJR26MIL-STD-202 Method 106
 96 hours (1% ΔTR, 100 Megohms IR)
 Vibration
 326230G (1% ΔTR; 1% ΔVR)
 RJ26/RJR2620G (1% ΔTR; 1% ΔVR)
 Shock100G (1% ΔTR; 1% ΔVR)
 Load Life
 32621,000 hours 0.25 watt @ 85°C
 (3% ΔTR; 3% or 3 ohms,
 whichever is greater, CRV)
 RJ261,000 hours 0.25 watt @ 85°C
 (2% ΔTR; 1% ΔVR)
 RJR2610,000 hours 0.25 watt @ 85°C
 (3% ΔTR)
 Rotational Life200 cycles
 3262(2% ΔTR; 3% or 3 ohms,
 whichever is greater, CRV)
 RJ26/RJR26(2% ΔTR)

Physical Characteristics

Torque3.0 oz-in. max.
 Mechanical StopsWiper idles
 Terminals
 3262Solderable pins
 RJ26/RJR26MIL-STD-202; Method 208

*"FLUORINERT" IS A REGISTERED TRADEMARK OF 3M CO.

Specifications are subject to change without notice.

Physical Characteristics (cont.)

Weight0.015 oz.
 Marking
 3262Manufacturer's trademark,
 resistance code, wiring diagram,
 date code, manufacturer's model
 number and style
 RJ26/RJR26Mil-spec part number
 WiperPositioned at 50% nominal
 FlammabilityU.L. 94V-0
 Standard Packaging50 pcs. per tube
 Adjustment ToolH-90

How To Order

3262 P - 1 - 103

Model _____
 Style _____
 Standard or Modified
 Product Indicator
 -1 = Standard Product
 Resistance Code _____

See page 82 for RJ26/RJR26 ordering information.

Consult factory for other available options.

3262W/RJ26/RJR26 Common Dimensions

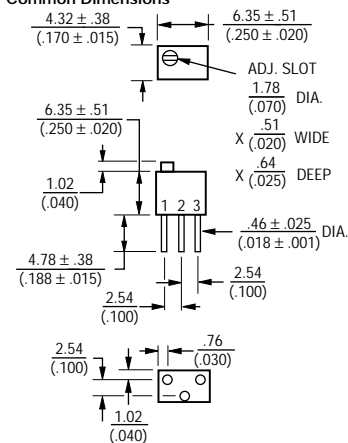

3262X/RJ26/RJR26

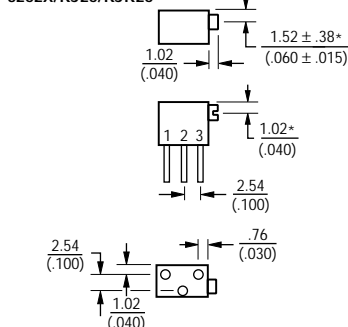

*Common dimensions

3262P/RJ26/RJR26

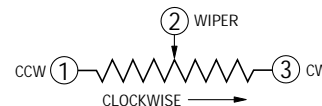
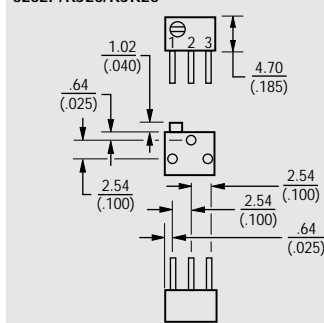

TOLERANCES: ± 0.25 (.010) EXCEPT WHERE NOTED

DIMENSIONS ARE: METRIC
 (INCHES)

Standard Resistance Table

| Resistance (Ohms) | Resistance Code |
|-------------------|-----------------|
| 10 | 100 |
| 20 | 200 |
| 50 | 500 |
| 100 | 101 |
| 200 | 201 |
| 500 | 501 |
| 1,000 | 102 |
| 2,000 | 202 |
| 5,000 | 502 |
| 10,000 | 103 |
| 20,000 | 203 |
| 25,000 | 253 |
| 50,000 | 503 |
| 100,000 | 104 |
| 200,000 | 204 |
| 250,000 | 254 |
| 500,000 | 504 |
| 1,000,000 | 105 |

Popular values listed in boldface. Special resistances available.

SHADED AREAS TYPICALLY NOT STOCKED BY DISTRIBUTORS AND NOT RECOMMENDED FOR NEW DESIGNS.

AVAILABLE THROUGH DISTRIBUTION

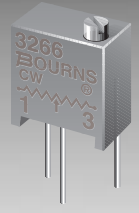

BOURNS

Features

- Multiturn / Cermet / Industrial / Sealed
- Standoffs allow thorough PC board washing
- Tape and reel packaging available (see page 70 for details)
- Patent #4427966 drive mechanism

3266 - 1/4" Square Trimming Potentiometer

Electrical Characteristics

Standard Resistance Range10 to 1 megohm
 (see standard resistance table)
 Resistance Tolerance±10% std.
 Absolute Minimum Resistance1% or 2 ohms max.
 (whichever is greater)
 Contact Resistance Variation3.0% or 3 ohms max.
 (whichever is greater)
 Adjustability
 Voltage±0.02%
 Resistance±0.05%
 ResolutionInfinite
 Insulation Resistance500 vdc.
 1,000 megohms min.
 Dielectric Strength
 Sea Level600 vac
 80,000 Feet250 vac
 Effective Travel12 turns nom.

Environmental Characteristics

Power Rating (300 volts max.)
 70°C0.25 watt
 150°C0 watt
 Temperature Range-55°C to +150°C
 Temperature Coefficient±100ppm/°C
 Seal Test85°C Fluorinert*
 HumidityMIL-STD-202 Method 103
 96 hours (2% ΔTR, 10 Megohms IR)
 Vibration30G (1% ΔTR; 1% ΔVR)
 Shock100G (1% ΔTR; 1% ΔVR)
 Load Life1,000 hours 0.25 watt 70°C
 (3% ΔTR; 3% CRV)
 Rotational Life200 cycles
 (4% ΔTR; 3% or 3 ohms, whichever is greater, CRV)

Physical Characteristics

Torque3.0 oz-in. max.
 Mechanical StopsWiper idles
 TerminalsSolderable pins
 Weight0.015 oz.
 MarkingManufacturer's trademark, resistance code, wiring diagram, date code, manufacturer's model number and style
 WiperPositioned at 50% nominal
 FlammabilityU.L. 94V-0
 Standard Packaging50 pcs. per tube
 Adjustment ToolH-90

*"FLUORINERT" IS A REGISTERED TRADEMARK OF 3M CO.

3266W Common Dimensions

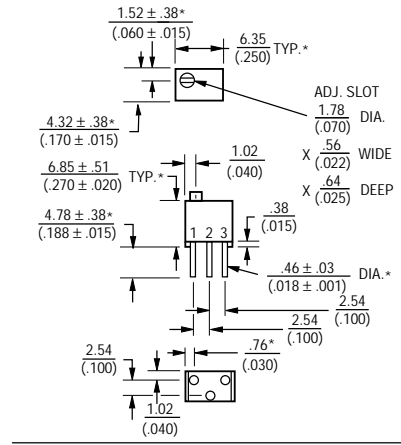

3266P

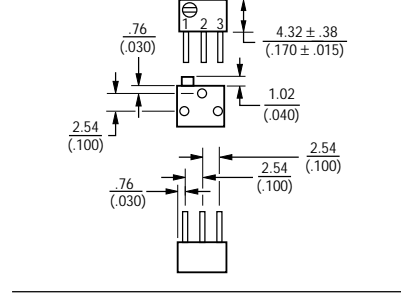

3266X

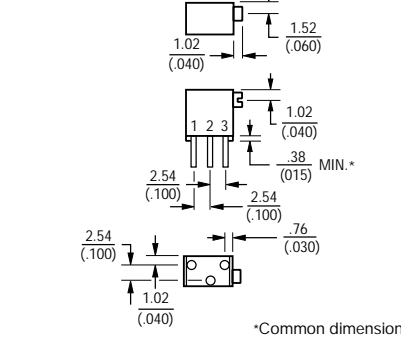

TOLERANCES: ± 0.25 (.010) EXCEPT WHERE NOTED
 DIMENSIONS ARE: METRIC (INCHES)

How to Order

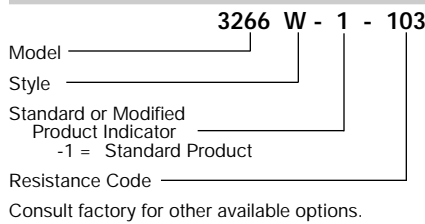

3266Y

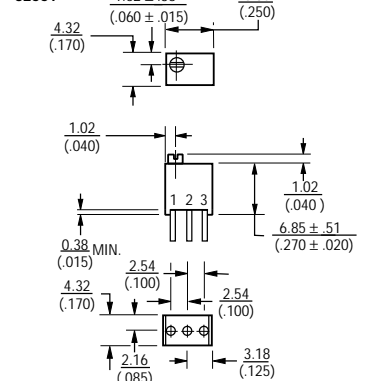

3266Z

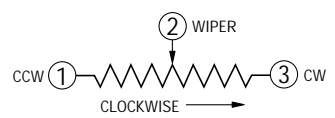
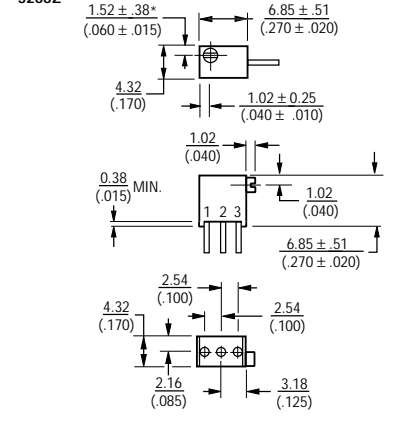

Standard Resistance Table

| Resistance (Ohms) | Resistance Code |
|-------------------|-----------------|
| 10 | 100 |
| 20 | 200 |
| 50 | 500 |
| 100 | 101 |
| 200 | 201 |
| 500 | 501 |
| 1,000 | 102 |
| 2,000 | 202 |
| 5,000 | 502 |
| 10,000 | 103 |
| 20,000 | 203 |
| 25,000 | 253 |
| 50,000 | 503 |
| 100,000 | 104 |
| 200,000 | 204 |
| 250,000 | 254 |
| 500,000 | 504 |
| 1,000,000 | 105 |

Popular values listed in boldface. Special resistances available.
 SHADED AREAS TYPICALLY NOT STOCKED BY DISTRIBUTORS AND NOT RECOMMENDED FOR NEW DESIGNS.

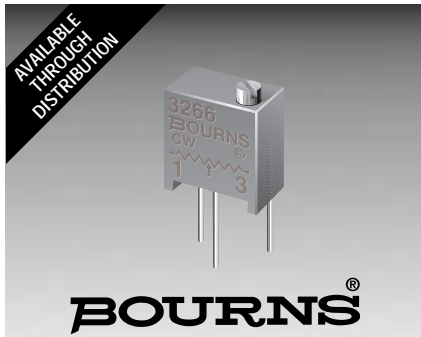

Features

- Low TCR
- Multiturn / Cermet / Industrial / Sealed
- Standoffs allow thorough PC board washing
- Patent #4427966 drive mechanism

Applications

- Rheostat applications with wiper currents less than 25 microamps
- Process control instrumentation
- Power supplies

3266-LTC - 1/4" Square Trimming Potentiometer

Electrical Characteristics

Standard Resistance Range2K to 25K ohms
 (see standard resistance table)
 Resistance Tolerance±10% std.
 Absolute Minimum Resistance1% or 2 ohms max.
 (whichever is greater)
 Contact Resistance Variation3.0% or 3 ohms max.
 (whichever is greater)
 Adjustability
 Voltage±0.02%
 Resistance±0.05%
 ResolutionInfinite
 Insulation Resistance500 vdc.
 1,000 megohms min.
 Dielectric Strength
 Sea Level600 vac
 80,000 Feet250 vac
 Effective Travel12 turns nom.

Environmental Characteristics

Power Rating (300 volts max.)
 70°C0.25 watt
 150°C0 watt
 Temperature Range-55°C to +150°C
 Temperature Coefficient
 End to End±20ppm/°C
 Through the Wiper±50ppm/°C
 Seal Test85°C Fluorinert*
 HumidityMIL-STD-202 Method 103
 96 hours (2% ΔTR, 10 Megohms IR)
 Vibration30G (1% ΔTR; 1% ΔVR)
 Shock100G (1% ΔTR; 1% ΔVR)
 Load Life1,000 hours 0.25 watt 70°C
 (3% ΔTR; 3% CRV)
 Rotational Life200 cycles
 (4% ΔTR; 3% or 3 ohms, whichever is greater, CRV)

Physical Characteristics

Torque3.0 oz-in. max.
 Mechanical StopsWiper idles
 TerminalsSolderable pins
 Weight0.015 oz.
 MarkingManufacturer's trademark, resistance code, wiring diagram, date code, manufacturer's model number and style
 WiperPositioned at 50% nominal
 FlammabilityU.L. 94V-0
 Standard Packaging50 pcs. per tube
 Adjustment ToolH-90

NOTE: TCR through the wiper applies when 40% or more of the resistance element is in the circuit.

*"FLUORINERT" IS A REGISTERED TRADEMARK OF 3M CO.

3266W

Common Dimensions

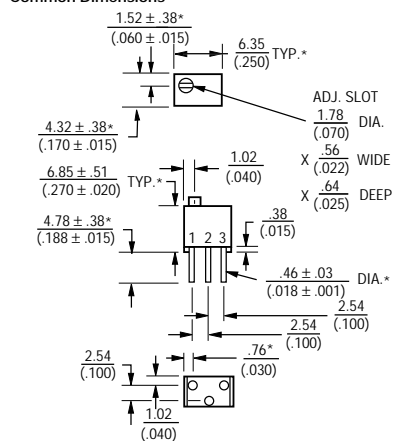

3266P

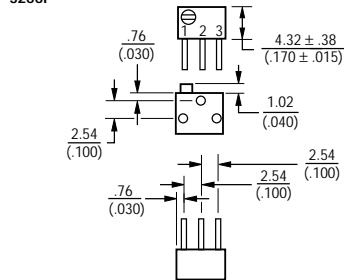

3266X

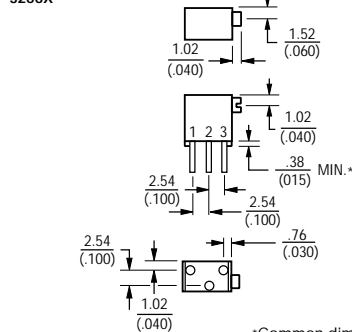

*Common dimensions

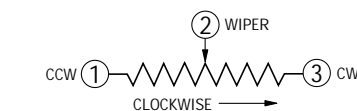

TOLERANCES: ± 0.25 (.010) EXCEPT WHERE NOTED

DIMENSIONS ARE: METRIC (INCHES)

Standard Resistance Table

| Resistance (Ohms) | Resistance Code |
|-------------------|-----------------|
| 2,000 | 202 |
| 5,000 | 502 |
| 10,000 | 103 |
| 20,000 | 203 |
| 25,000 | 253 |

Popular values listed in boldface. Special resistances available.

How To Order

Model **3266** W - LTC - **103**
 Style _____
 Product Indicator _____
 Resistance Code _____
 Consult factory for other available options.

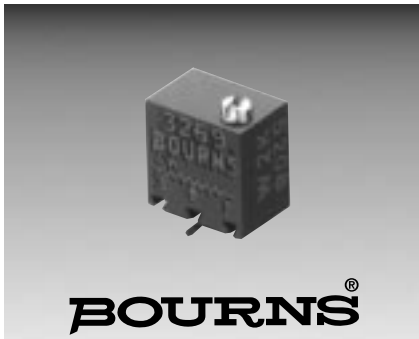

BOURNS®

Features

- Stable, infinite resolution cermet element
- Vertical and horizontal adjust styles
- Optional packaging on embossed tape
- Compatible with surface mount manufacturing processes

3269 - 1/4" Square SMD Trimming Potentiometer

Electrical Characteristics

Standard Resistance Range10 to 1 megohm
 (see standard resistance table)
 Resistance Tolerance±10% std.
 (closer tolerance available)
 Absolute Minimum Resistance1% or 2 ohms max.
 (whichever is greater)
 Contact Resistance Variation3.0% or 3 ohms max.
 (whichever is greater)
 Adjustability
 Voltage±0.02%
 Resistance±0.05%
 Resolution.....Infinite
 Insulation Resistance500 vdc.
 1,000 megohms min.
 Dielectric Strength
 Sea Level600 vac
 80,000 Feet.....250 vac
 Effective Travel.....12 turns nom.

Environmental Characteristics

Maximum Exposure (Temp/Time) +245°C/10 sec.
 Power Rating (300 volts max.)
 85°C0.25 watt
 150°C0 watt
 Temperature Range-65°C to +150°C
 Temperature Coefficient±100ppm/°C
 Seal Test85°C Fluorinert*
 Humidity.....MIL-STD-202 Method 106
 (2% ΔTR; IR 100 Megohms)
 Vibration.....30G (1% ΔTR; 1% ΔVR)
 Shock.....100G (1% ΔTR; 1% ΔVR)
 Load Life...1,000 hours 0.25 watt @ 85°C
 (3% ΔTR; 3% or 3 ohms
 whichever is greater, CRV)
 Rotational Life200 cycles
 (2% ΔTR; 3% or 3 ohms,
 whichever is greater, CRV)

Physical Characteristics

Torque3.0 oz-in. max.
 Mechanical Stops.....Wiper idles
 TerminalsSolderable pins
 Weight0.015 oz.
 MarkingManufacturer's
 trademark, resistance code,
 wiring diagram, date code,
 manufacturer's model
 number and style
 Standard Packaging50 pcs. per tube
 Adjustment ToolH-90

3269P

Common Dimensions

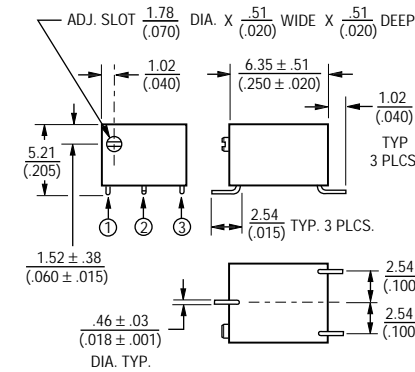

3269W

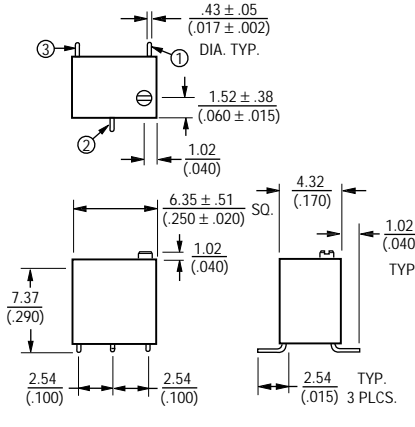

3269X

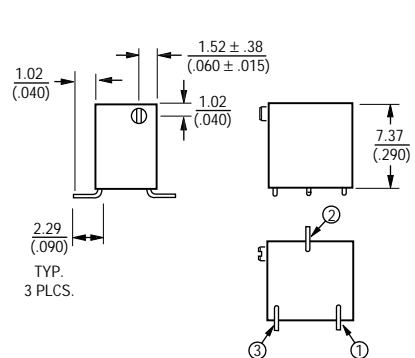

RECOMMENDED PCB LAYOUT - "P"

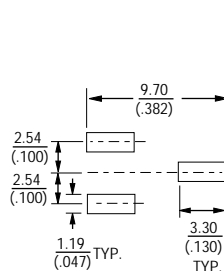

RECOMMENDED PCB LAYOUT - "W" & "X"

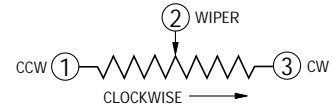
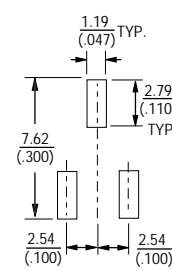

TOLERANCES: ± 0.25 (.010) EXCEPT WHERE NOTED

DIMENSIONS ARE: METRIC (INCHES)

How To Order

Model **3269 X - 1 - 103 G**
 Style _____
 Standard Product _____
 Resistance Code _____
 Optional Suffix Letter _____
 G = Embossed Tape
 "P" Style - 750 pcs./13" reel
 "W, X" Style - 500 pcs./13" reel

Standard Resistance Table

| Resistance (Ohms) | Resistance Code |
|-------------------|-----------------|
| 10 | 100 |
| 20 | 200 |
| 50 | 500 |
| 100 | 101 |
| 200 | 201 |
| 500 | 501 |
| 1,000 | 102 |
| 2,000 | 202 |
| 5,000 | 502 |
| 10,000 | 103 |
| 20,000 | 203 |
| 25,000 | 253 |
| 50,000 | 503 |
| 100,000 | 104 |
| 200,000 | 204 |
| 250,000 | 254 |
| 500,000 | 504 |
| 1,000,000 | 105 |

SHADED AREAS TYPICALLY NOT STOCKED BY DISTRIBUTORS AND NOT RECOMMENDED FOR NEW DESIGNS.

*"FLUORINERT" IS A REGISTERED TRADEMARK OF 3M CO.

3269 - Packaging Specifications



Packaging Specifications

(P Style)

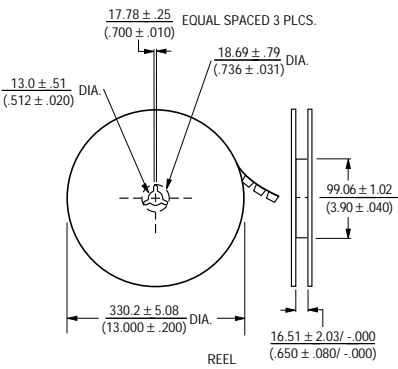
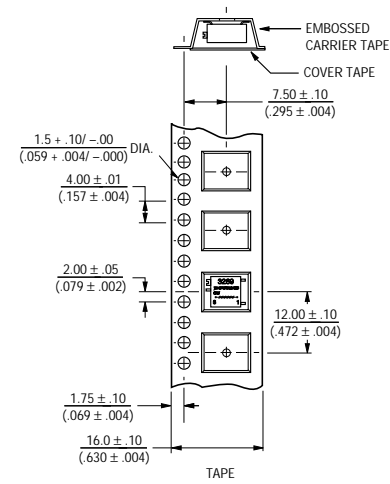

Units packaged 750 pieces per reel.

Packaging Specifications

(W & X Styles)

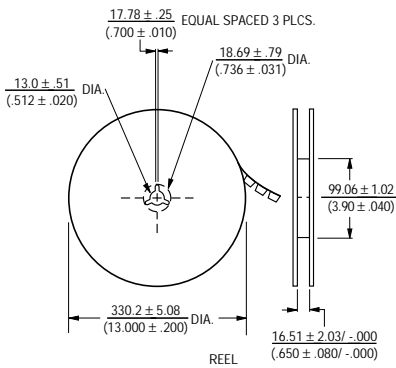
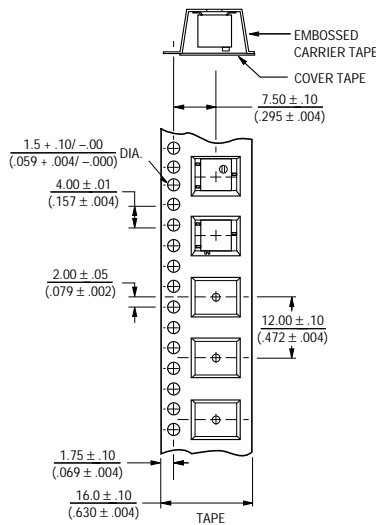

Units packaged 500 pieces per reel.

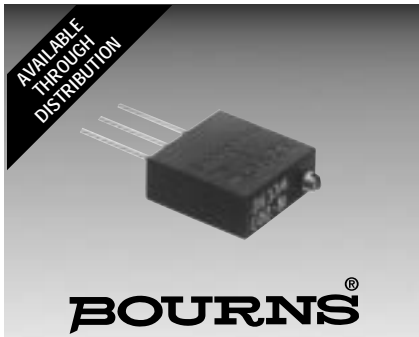

Features

- Multiturn/ Wirewound / Industrial / Sealed
- Listed on the QPL for style RT24 per MIL-R-27208 and RTR24 per High-Rel MIL-R-39015
- Panel mount option available (see page 73 for details)

3290/RT24/RTR24 - 3/8" Square Trimming Potentiometer

Electrical Characteristics

| | |
|-----------------------------|---------------------------------|
| Standard Resistance Range | |
| 3290 | 10 to 50K ohms |
| RT24 | 10 to 10K ohms |
| RTR24 | 500 to 10K ohms |
| | (see standard resistance table) |
| Resistance Tolerance | ±5% std. |
| | (tighter tolerance available) |
| Absolute Minimum Resistance | |
| | 0.1% or 1 ohm max. |
| | (whichever is greater) |
| Noise | 100 ohms ENR max. |
| Resolution | |
| | (see standard resistance table) |
| Insulation Resistance | |
| | 500 vdc. |
| | 1,000 megohms min. |
| Dielectric Strength | |
| Sea Level | 1,000 vac |
| 80,000 Feet | 350 vac |
| Adjustment Travel | .25 turns nom. |

Environmental Characteristics

| | |
|-------------------------------|-----------------------------------|
| Power Rating @ 85°C | |
| 3290 | 1.0 watt |
| RT24/RTR24 | 0.75 watt |
| Power Rating @ 150°C | |
| | 0 watt |
| Temperature Range | |
| | -65°C to +150°C |
| Temperature Coefficient | |
| | ±50ppm/°C |
| Seal Test | |
| | 85°C Fluorinert* |
| Humidity | |
| 3290 | MIL-STD-202 Method 106 |
| | 96 hours (2% ΔTR; 100 Megohms IR) |
| RT24 | (1% ΔTR; 10 Megohms IR) |
| RTR24 | (1% ΔTR; 100 Megohms IR) |
| Vibration | |
| 3290 | 30G |
| | (1% ΔTR; 0.5% + resolution ΔVR) |
| RT24/RTR24 | 20G |
| | (1% ΔTR; 0.5% + resolution ΔVR) |
| Shock | |
| | 100G |
| | (1% ΔTR; 0.5% + resolution ΔVR) |
| Load Life | |
| 3290 | 1,000 hours 1.0 watt @ 85°C |
| | (2% ΔTR; 500 ohms ENR) |
| RT24 | 1,000 hours 0.75 watt @ 85°C |
| | (2% ΔTR; 2% + resolution ΔVR) |
| RTR24 | 10,000 hours 0.75 watt @ 85°C |
| | (3% + resolution ΔVR) |
| Rotational Life | |
| | 200 cycles |
| 3290 | (2% ΔTR; 500 ohms ENR) |
| RT24/RTR24 | (2% ΔTR) |

Physical Characteristics

| | |
|------------------------|---------------------------------|
| Torque | 5.0 oz-in. max. |
| Mechanical Stops | Wiper idles |
| Terminals | |
| 3290 | Solderable printed circuit pins |
| RT24/RTR24 | MIL-STD-202; Method 208 |
| Weight | 0.025 oz. |

Physical Characteristics (cont.)

| | |
|--------------------------|---|
| Marking | |
| 3290 | Manufacturer's trademark, resistance code, wiring diagram, date code, manufacturer's model number and style |
| RT24/RTR24 | Mil-spec part number |
| Wiper | Positioned at 50% nominal |
| Flammability | U.L. 94V-0 |
| Standard Packaging | 50 pcs. per tube |
| Adjustment Tool | H-90 |

How to Order

| | |
|--|-------------------------------------|
| 3290 H - 1 - 103 M | |
| Model | _____ |
| Style | _____ |
| Standard or Modified Product Indicator | _____ |
| | -1 = Standard Product |
| Resistance Code | _____ |
| Optional Suffix Letter | _____ |
| | M = Panel Mount (Factory Installed) |

See page 81 for RT24/RTR24 ordering information.
Consult factory for other available options.

3290H/RT24X/RTR24X Common Dimensions

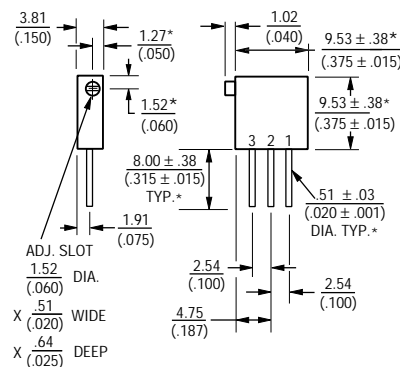

3290P/RT24/RTR24

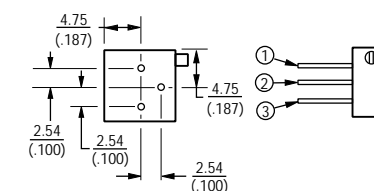

*Common dimensions

3290W/RT24/RTR24

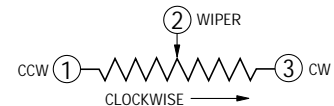
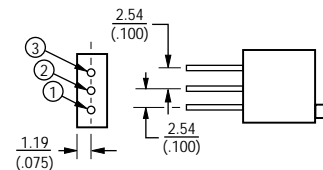

TOLERANCES: ± 0.25 (.010) EXCEPT WHERE NOTED

DIMENSIONS ARE: $\frac{\text{METRIC}}{\text{(INCHES)}}$

Standard Resistance Table

| Resistance (Ohms) | Resistance Code | Nominal Resolution (Percent) |
|-------------------|-----------------|------------------------------|
| 10 | 100 | 1.11 |
| 20 | 200 | 0.93 |
| 50 | 500 | 0.62 |
| 100 | 101 | 0.60 |
| 200 | 201 | 0.54 |
| 500 | 501 | 0.42 |
| 1,000 | 102 | 0.33 |
| 2,000 | 202 | 0.26 |
| 5,000 | 502 | 0.20 |
| 10,000 | 103 | 0.17 |
| 20,000 | 203 | 0.14 |
| 25,000 | 253 | 0.13 |
| 50,000 | 503 | 0.11 |

Popular values listed in boldface. Special resistances available.

SHADED AREAS TYPICALLY NOT STOCKED BY DISTRIBUTORS AND NOT RECOMMENDED FOR NEW DESIGNS.

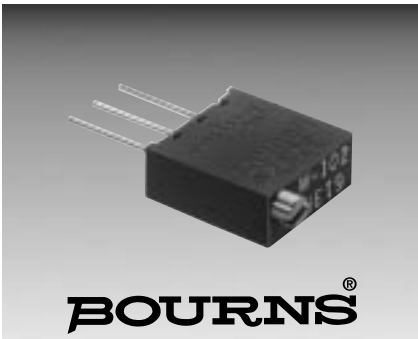

Features

- Multiturn / Cermet / Industrial / Sealed
- Optional panel mount available (see page 73 for details)
- Patent #4427966 drive mechanism
- Thin body profile

3292 - 3/8" Square Trimming Potentiometer

Electrical Characteristics

Standard Resistance Range10 to 1 megohm
 (see standard resistance table)
 Resistance Tolerance±10% std.
 (tighter tolerance available)
 Absolute Minimum Resistance1% or 2 ohms max.
 (whichever is greater)
 Contact Resistance Variation
 3292.....1.0% or 3 ohms max.
 (whichever is greater)
 Adjustability
 Voltage.....±0.01%
 Resistance.....±0.05%
 Resolution.....Infinite
 Insulation Resistance500 vdc.
 1,000 megohms min.
 Dielectric Strength
 Sea Level.....1,000 vac
 80,000 Feet.....400 vac
 Effective Travel.....25 turns nom.

Environmental Characteristics

Power Rating (400 volts max.)
 85°C0.5 watt
 150°C0 watt
 Temperature Range.....-65°C to +150°C
 Temperature Coefficient±100ppm/°C
 Seal Test85°C Fluorinert*
 (pin styles only)
 Humidity.....MIL-STD-202 Method 103
 96 hours (1% ΔTR, 100 Megohms IR)
 Vibration.....30G (1% ΔTR; 1% ΔVR)
 Shock.....100G (1% ΔTR; 1% ΔVR)
 Load Life ..1,000 hours 0.5 watt @ 85°C
 (2% ΔTR; 3% or 3 ohms, whichever is greater, CRV)
 Rotational Life200 cycles
 (2% ΔTR; 3% or 3 ohms, whichever is greater, CRV)

Physical Characteristics

Torque5.0 oz-in. max.
 Mechanical Stops.....Wiper idles
 Terminals
Solderable printed circuit pins
 Weight0.025 oz.
 Machine Screw Mounting
 Torque12 oz-in. max.
 Marking
Manufacturer's trademark,
 resistance code, wiring diagram, date
 code, manufacturer's model number
 and style
 WiperPositioned at 50% nominal
 Flammability.....U.L. 94V-0
 Standard Packaging
 P,W & X Styles.....50 pcs. per tube
 L Style50 pcs. per bag
 Adjustment ToolH-90

Specifications are subject to change without notice.

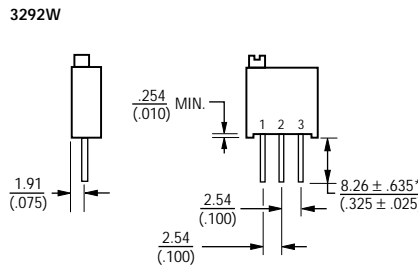
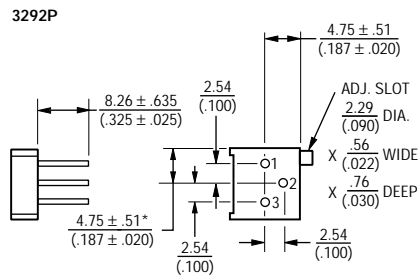
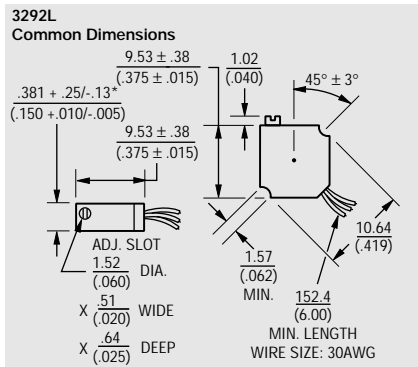

*Common dimensions

TOLERANCES: ± 0.25 (.010) EXCEPT WHERE NOTED

DIMENSIONS ARE: METRIC (INCHES)

How To Order

3292 W - 1 - 103 M

Model _____
 Style _____
 Standard or Modified Product Indicator
 -1 = Standard Product
 Resistance Code _____
 Optional Suffix Letter _____
 M = Panel Mount Model 3292L, W & X (Factory Installed)

Consult factory for other available options.

*"FLUORINERT" IS A REGISTERED TRADEMARK OF 3M CO.

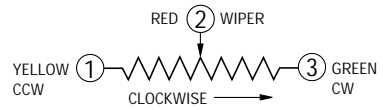
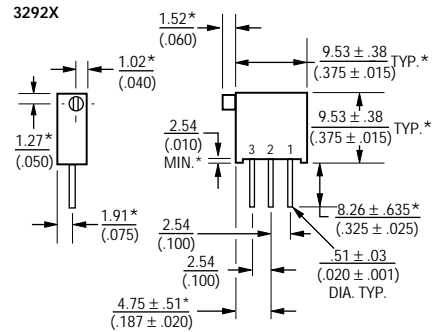

Standard Resistance Table

| Resistance (Ohms) | Resistance Code |
|-------------------|-----------------|
| 10 | 100 |
| 20 | 200 |
| 50 | 500 |
| 100 | 101 |
| 200 | 201 |
| 500 | 501 |
| 1,000 | 102 |
| 2,000 | 202 |
| 5,000 | 502 |
| 10,000 | 103 |
| 20,000 | 203 |
| 25,000 | 253 |
| 50,000 | 503 |
| 100,000 | 104 |
| 200,000 | 204 |
| 250,000 | 254 |
| 500,000 | 504 |
| 1,000,000 | 105 |

Popular values listed in boldface. Special resistances available.

SHADED AREAS TYPICALLY NOT STOCKED BY DISTRIBUTORS AND NOT RECOMMENDED FOR NEW DESIGNS.

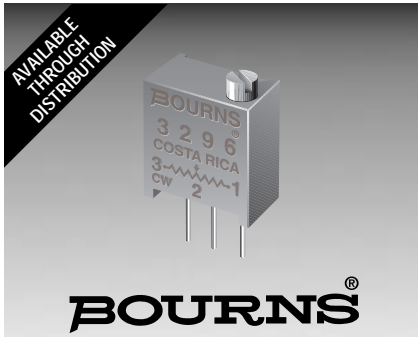

Features

- Multiturn / Cermet / Industrial / Sealed
- 5 terminal styles
- Tape and reel packaging available
- Chevron seal design
- Listed on the QPL for style RJ24 per MIL-R-22097 and RJ24 per High-Rel Mil-R-39035

3296 - 3/8" Square Trimming Potentiometer

Electrical Characteristics

| | |
|------------------------------|--|
| Standard Resistance Range | 10 to 5 megohms (see standard resistance table) |
| Resistance Tolerance | ±10% std. (tighter tolerance available) |
| Absolute Minimum Resistance | 1% or 2 ohms max. (whichever is greater) |
| Contact Resistance Variation | 1.0% or 3 ohms max. (whichever is greater) |
| Adjustability | |
| Voltage | ±0.01% |
| Resistance | ±0.05% |
| Resolution | Infinite |
| Insulation Resistance | 500 vdc. 1,000 megohms min. |
| Dielectric Strength | |
| Sea Level | 900 vac |
| 70,000 Feet | 350 vac |
| Effective Travel | 25 turns nom. |

Environmental Characteristics

| | |
|-------------------------------|---|
| Power Rating (300 volts max.) | |
| 70°C | 0.5 watt |
| 125°C | 0 watt |
| Temperature Range | -55°C to +150°C |
| Temperature Coefficient | ±100ppm/°C |
| Seal Test | 85°C Fluorinert* |
| Humidity | MIL-STD-202 Method 103 96 hours (2% ΔTR, 10 Megohms IR) |
| Vibration | 20G (1% ΔTR; 1% ΔVR) |
| Shock | 100G (1% ΔTR; 1% ΔVR) |
| Load Life | 1,000 hours 0.5 watt @ 70°C (3% ΔTR; 3% or 3 ohms, whichever is greater, CRV) |
| Rotational Life | 200 cycles (4% ΔTR; 3% or 3 ohms, whichever is greater, CRV) |

Physical Characteristics

| | |
|--------------------|---|
| Torque | 3.0 oz-in. max. |
| Mechanical Stops | Wiper idles |
| Terminals | Solderable pins |
| Weight | 0.03 oz. |
| Marking | Manufacturer's trademark, resistance code, wiring diagram, date code, manufacturer's model number and style |
| Wiper | Positioned at 50% nominal |
| Flammability | U.L. 94V-0 |
| Standard Packaging | 50 pcs. per tube |
| Adjustment Tool | H-90 |

Common Dimensions

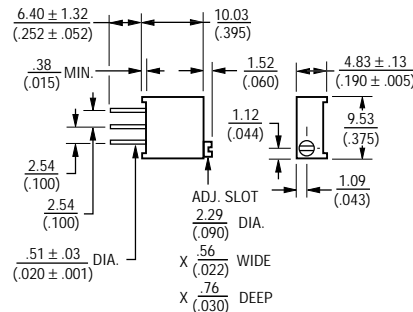

3296P

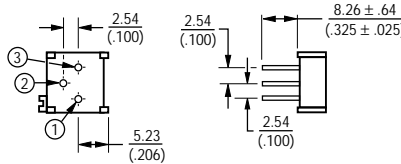

3296W

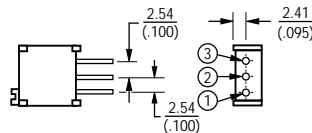

3296X

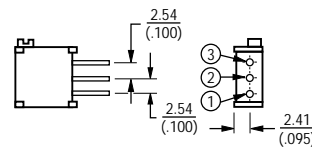

How To Order

| | |
|-----------------------|------------------|
| Model | 3296 W - 1 - 103 |
| Style | |
| Standard or Modified | |
| Product Indicator | |
| -1 = Standard Product | |
| Resistance Code | |

Consult factory for other available options.

3296Y (Commercial Only)

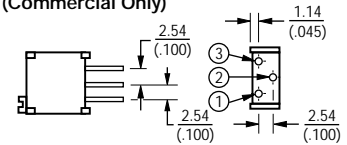

3296Z (Commercial Only)

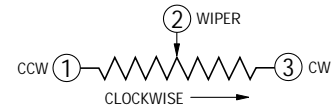
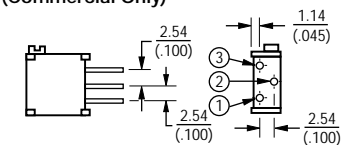

TOLERANCES: ± 0.25 (.010) EXCEPT WHERE NOTED

DIMENSIONS ARE: $\frac{\text{METRIC}}{\text{(INCHES)}}$

Standard Resistance Table

| Resistance (Ohms) | Resistance Code |
|-------------------|-----------------|
| 10 | 100 |
| 20 | 200 |
| 50 | 500 |
| 100 | 101 |
| 200 | 201 |
| 500 | 501 |
| 1,000 | 102 |
| 2,000 | 202 |
| 5,000 | 502 |
| 10,000 | 103 |
| 20,000 | 203 |
| 25,000 | 253 |
| 50,000 | 503 |
| 100,000 | 104 |
| 200,000 | 204 |
| 250,000 | 254 |
| 500,000 | 504 |
| 1,000,000 | 105 |
| 2,000,000 | 205 |

Popular values listed in boldface. Special resistances available.

*FLUORINERT® IS A REGISTERED TRADEMARK OF 3M CO.

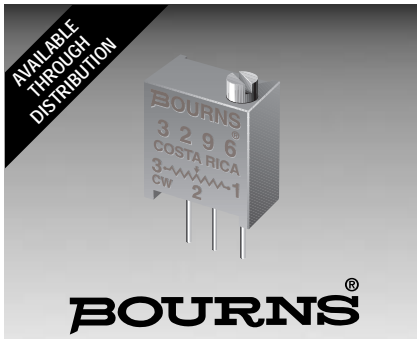

Features

- Low TCR
- Multiturn / Cermet / Industrial / Sealed
- 3 terminal styles
- Chevron seal design

Applications

- Rheostat applications with wiper currents less than 25 microamps
- Process control instrumentation
- Power supplies

3296-LTC - 3/8" Square Trimming Potentiometer

Electrical Characteristics

Standard Resistance Range2K to 25K ohms
 (see standard resistance table)
 Resistance Tolerance±10% std.
 (tighter tolerance available)
 Absolute Minimum Resistance1% or 2 ohms max.
 (whichever is greater)
 Contact Resistance Variation1.0% or 3 ohms max.
 (whichever is greater)
 Adjustability
 Voltage±0.01%
 Resistance±0.05%
 ResolutionInfinite
 Insulation Resistance500 vdc.
 1,000 megohms min.
 Dielectric Strength
 Sea Level900 vac
 70,000 Feet350 vac
 Effective Travel25 turns nom.

Environmental Characteristics

Power Rating (300 volts max.)
 70°C0.5 watt
 125°C0 watt
 Temperature Range-55°C to +150°C
 Temperature Coefficient
 End to End±20ppm/°C
 Through the Wiper±50ppm/°C
 Seal Test85°C Fluorinert*
 HumidityMIL-STD-202 Method 103
 96 hours
 (2% ΔTR, 10 Megohms IR)
 Vibration20G (1% ΔTR; 1% ΔVR)
 Shock100G (1% ΔTR; 1% ΔVR)
 Load Life1,000 hours 0.5 watt @ 70°C
 (3% ΔTR; 3% or 3 ohms, whichever is greater, CRV)
 Rotational Life200 cycles
 (4% ΔTR; 3% or 3 ohms, whichever is greater, CRV)

Physical Characteristics

Torque3.0 oz-in. max.
 Mechanical StopsWiper idles
 TerminalsSolderable pins
 Weight0.03 oz.
 MarkingManufacturer's trademark, resistance code, wiring diagram, date code, manufacturer's model number and style
 WiperPositioned at 50% nominal
 FlammabilityU.L. 94V-0
 Standard Packaging50 pcs. per tube
 Adjustment ToolH-90

Common Dimensions

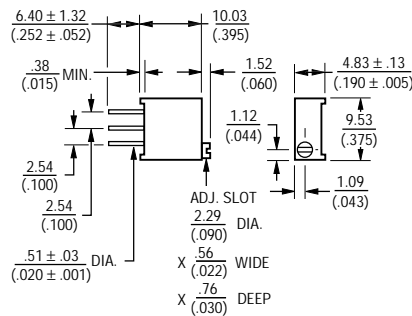

3296P

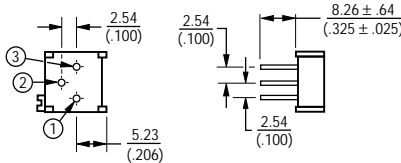

3296W

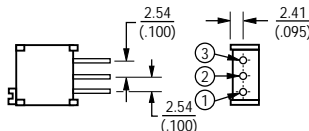

3296X

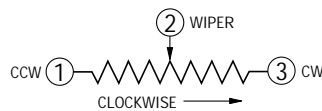
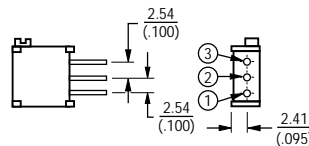

TOLERANCES: ± 0.25 (.010) EXCEPT WHERE NOTED

DIMENSIONS ARE: METRIC (INCHES)

Standard Resistance Table

| Resistance (Ohms) | Resistance Code |
|-------------------|-----------------|
| 2,000 | 202 |
| 5,000 | 502 |
| 10,000 | 103 |
| 20,000 | 203 |
| 25,000 | 253 |

Popular values listed in boldface. Special resistances available.

How To Order

3296 W - LTC - 103

Model _____
 Style _____
 Product Indicator _____
 Resistance Code _____
 Consult factory for other available options.

NOTE: TCR through the wiper applies when 40% or more of the resistance element is in the circuit.

*"FLUORINERT" IS A REGISTERED TRADEMARK OF 3M CO.

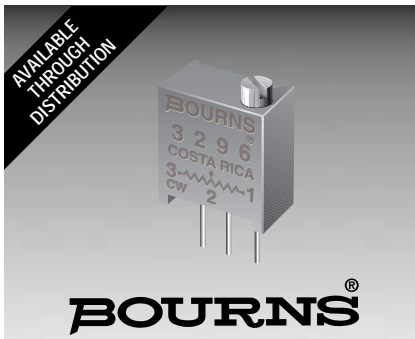

Features

- Multiturn / Cermet / Industrial / Sealed
- Standoffs
- Patent #4427966 drive mechanism
- Listed on the QPL for style RJ24 per MIL-R-22097 and RJR24 per High-Rel Mil-R-39035

RJ24/RJR24 - 3/8" Square Trimming Potentiometer

Electrical Characteristics

Standard Resistance Range 10 to 1 megohm
 (see standard resistance table)
 Resistance Tolerance ±10% std.
 Absolute Minimum Resistance 1 ohm max.
 Contact Resistance Variation 3.0% or 3 ohms max.
 (whichever is greater)
 Adjustability
 Voltage ±0.01%
 Resistance ±0.05%
 Resolution Infinite
 Insulation Resistance 500 vdc.
 1,000 megohms min.
 Dielectric Strength
 Sea Level 1,000 vac
 80,000 Feet 400 vac
 Effective Travel 25 turns nom.

Environmental Characteristics

Power Rating (300 volts max.)
 85°C 0.5 watt
 150°C 0 watt
 Temperature Range -55°C to +150°C
 Temperature Coefficient ±100ppm/°C
 Seal Test 85°C Fluorinert*
 Humidity MIL-STD-202 Method 106
 RJ24 96 hours
 (1% ΔTR, 10 Megohms IR)
 RJR24 96 hours
 (1% ΔTR, 100 Megohms IR)
 Vibration 20G (1% ΔTR; 1% ΔVR)
 Shock 100G (1% ΔTR; 1% ΔVR)
 Load Life
 RJ24 1,000 hours 0.5 watt @ 85°C
 (2% ΔTR; 10% ΔVR)
 RJR24 10,000 hours 0.5 watt @ 85°C
 (3% ΔTR)
 Rotational Life 200 cycles (2% ΔTR)

Physical Characteristics

Torque 5.0 oz-in. max.
 Mechanical Stops Wiper idles
 Terminals MIL-STD 202, Method 208
 Weight 0.025 oz.
 Marking Mil-spec part number,
 date code
 Wiper Positioned at 50% nominal
 Flammability U.L. 94V-0
 Standard Packaging 50 pcs. per tube
 Adjustment Tool H-90

Common Dimensions

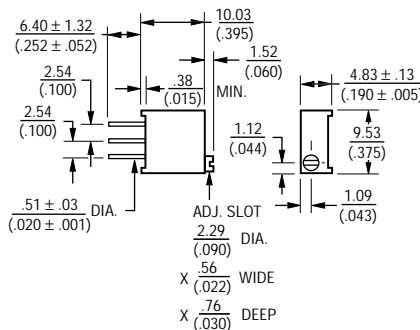

RJ24/RJR24FP

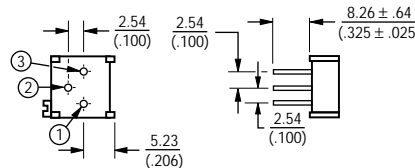

RJ24/RJR24FW

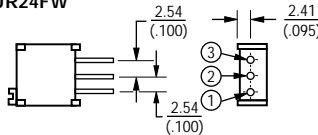

RJ24/RJR24FX

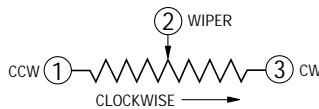
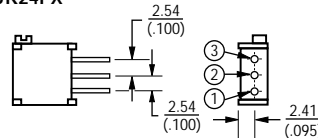

TOLERANCES: ± 0.25 (.010) EXCEPT WHERE NOTED

DIMENSIONS ARE: $\frac{\text{METRIC}}{\text{(INCHES)}}$

Standard Resistance Table

| Resistance (Ohms) | Resistance Code |
|-------------------|-----------------|
| 10 | 100 |
| 20 | 200 |
| 50 | 500 |
| 100 | 101 |
| 200 | 201 |
| 500 | 501 |
| 1,000 | 102 |
| 2,000 | 202 |
| 5,000 | 502 |
| 10,000 | 103 |
| 20,000 | 203 |
| 25,000 | 253 |
| 50,000 | 503 |
| 100,000 | 104 |
| 200,000 | 204 |
| 250,000 | 254 |
| 500,000 | 504 |
| 1,000,000 | 105 |

Popular values listed in boldface. Special resistances available.

How To Order

See page 81 for Model RJ24, and page 82 for Model RJR24.

*FLUORINERT® IS A REGISTERED TRADEMARK OF 3M CO.

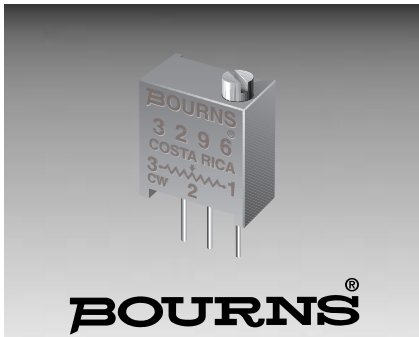

Features

- High Performance Series 3/8" Square / Multiturn / Cermet / Industrial / Sealed
- Thin body profile
- Sealed to withstand board washing processes
- Patent #4427966, #4732802, #4824694
- Low current applications <50uA

3296-LC2 - 3/8" Square Trimming Potentiometer

Electrical Characteristics

Standard Resistance Range500 ohms to 100K ohms
 (see standard resistance table)
 Resistance Tolerance±10% std.
 Absolute Minimum Resistance2 ohms or 1% max.
 (whichever is greater)
 Contact Resistance Variation0.5% max.
 Contact Resistance (D.C. mode)0.3% max.
 D.C. Offset0.5% max.
 Adjustability
 Voltage±0.1%
 Resistance±0.2%
 Insulation Resistance500 vdc.
 1,000 megohms min.
 Dielectric Strength
 Sea Level900 vac
 70,000 feet350 vac
 Adjustment Angle, Electrical
25 ±5 turns

Environmental Characteristics

Power Rating (400 volts max.)
 85°C0.5 watt
 125°C0 watt
 Temperature Range-55°C to +125°C
 Temperature Coefficient±100ppm/°C
 Humidity80-90% RH, 10 cycles
 2% max. TRS, IR 10 megohms
 0.2% max. contact resistance shift
 Seal Test85° C Flourinert*
 Vibration20G - 0.5% VRS
 0.2% contact resistance shift
 Shock100G - 0.5% VRS
 0.2% contact resistance shift
 Load Life @ 85°C Rated Power
1,000 hours 3% TRS,
 0.2% contact resistance shift - 0.5% CRV
 Rotational Life200 cycles, 4% TRS
 0.2% contact resistance shift
 Thermal Shock5 cycles
 2% TRS, 0.5% VRS
 0.2% contact resistance shift

Physical Characteristics

Torque3.0 oz-in. max.
 Mechanical StopsWiper idles
 TerminalsSolderable PC pins
 Weight0.03 oz.
 MarkingManufacturer's trademark, resistance code and date code
 WiperSet at CW end
 FlammabilityU.L. 94V-0
 Standard Packaging50 pcs. per tube
 Adjustment ToolH-90

Common Dimensions

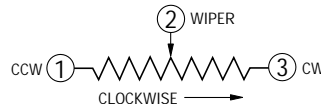
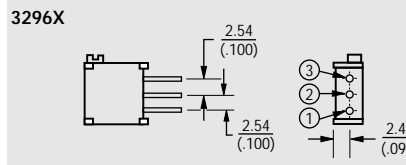
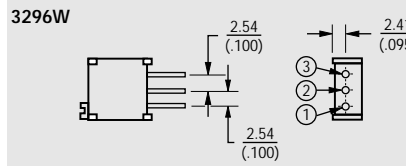
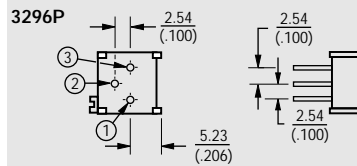
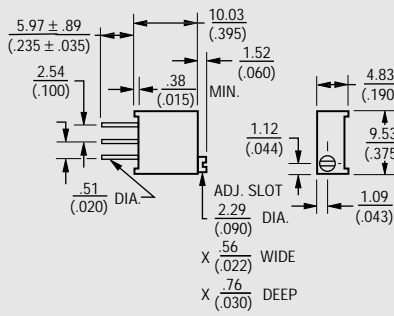

TOLERANCES: ± 0.25 (.010) EXCEPT WHERE NOTED

DIMENSIONS ARE: $\frac{\text{METRIC}}{\text{(INCHES)}}$

Standard Resistance Table

| Resistance (Ohms) | Resistance Code |
|-------------------|-----------------|
| 500 | 501 |
| 1,000 | 102 |
| 2,000 | 202 |
| 5,000 | 502 |
| 10,000 | 103 |
| 20,000 | 203 |
| 25,000 | 253 |
| 50,000 | 503 |
| 100,000 | 104 |

SHADED AREAS TYPICALLY NOT STOCKED BY DISTRIBUTORS AND NOT RECOMMENDED FOR NEW DESIGNS.

How To Order

Model 3296 W - LC2 - 103
 Style _____
 Product Indicator _____
 Resistance Code _____
 Consult factory for other available options.

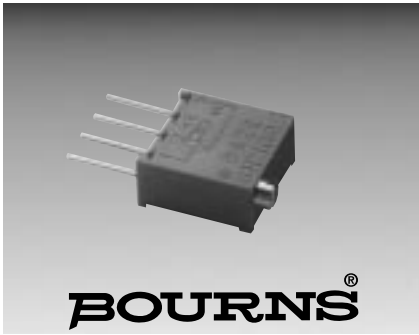

BOURNS®

Features

- 3/8" Square/ Multiturn / Cermet Industrial / Sealed
- Designed for operational amplifier offset voltage adjustment applications
- Reduces power supply drift errors
- Unique center tapped trimming potentiometer

- Vertical and horizontal adjust types available
- Patent #4427966 drive mechanism

3296-OT1 - 3/8" Square Trimming Potentiometer

Electrical Characteristics

Standard Resistance Range (Pin 1 to Pin 3)
100 ohms to 1 megohm
 (see standard resistance table)
 Resistance Tolerance±20% std.
 Absolute Minimum Resistance
2 ohms max.
 Voltage Output Variation.....+0.25%
 Adjustability (VR)±0.025%
 Insulation Resistance500 vdc.
1,000 megohms min.
 Dielectric Strength
 Sea Level900 vac
 70,000 Feet.....350 vac
 Effective Electrical Travel, Nom.
25 turns
 Center Tap Resistance2 ohms max.
 Center Tap Electrical Center.....±5%
 Center Tap Dead Band0.5 turn

Environmental Characteristics

Power Rating
 70°C0.5 watt
 125°C0 watt
 Temperature Range
-55°C to +125°C
 Temperature Stability (ΔVR)
±0.5% max.
 Seal Test85°C Fluorinert*
 Humidity.....MIL-STD-202 Method 103
 96 hours.....10 megohms min.
 Vibration, 20G±1% ΔTR
 Shock, 100G±1% ΔTR
 Load Life, 1,000 Hours±3% ΔTR
 Rotational Life, 200 cycles
±4% ΔTR

Physical Characteristics

Torque3.0 oz-in. max.
 Mechanical Stops.....Wiper idles
 TerminalsSolderable pins
 Weight0.03 oz.
 MarkingManufacturer's
 trademark, resistance code,
 wiring diagram, date code,
 manufacturer's model
 number and style
 FlammabilityU.L. 94V-0
 Standard Packaging
50 pcs. per tube/tray
 Adjustment ToolH-90

Also see Model 3386-OT1, page 62.

Common Dimensions

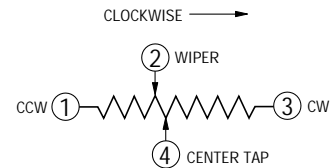
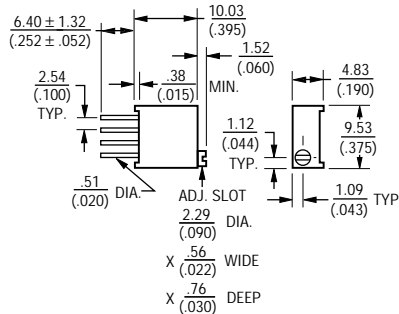

TOLERANCES: ± 0.25 (.010) EXCEPT WHERE NOTED

DIMENSIONS ARE: $\frac{\text{METRIC}}{\text{(INCHES)}}$

3296W-OT1

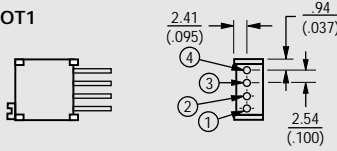

3296X-OT1

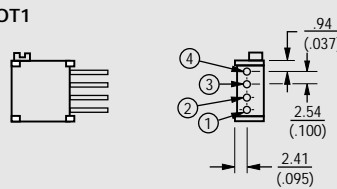

Standard Resistance Table

| Resistance (Ohms) | Resistance Code |
|-------------------|-----------------|
| 100 | 101 |
| 200 | 201 |
| 500 | 501 |
| 1,000 | 102 |
| 2,000 | 202 |
| 5,000 | 502 |
| 10,000 | 103 |
| 20,000 | 203 |
| 50,000 | 503 |
| 100,000 | 104 |
| 200,000 | 204 |
| 500,000 | 504 |
| 1,000,000 | 105 |

Popular values listed in boldface. Special resistances available.

SHADED AREAS TYPICALLY NOT STOCKED BY DISTRIBUTORS AND NOT RECOMMENDED FOR NEW DESIGNS.

Suggested Offset Voltage Adjustment Circuit

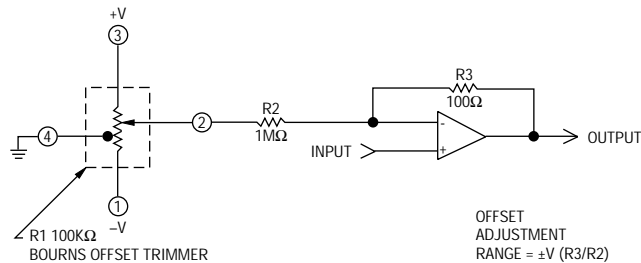

OFFSET ADJUSTMENT RANGE = ±V (R3/R2)

How To Order

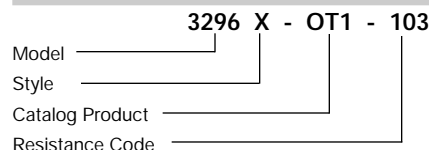

**FLUORINERT™ IS A REGISTERED TRADEMARK OF 3M CO.

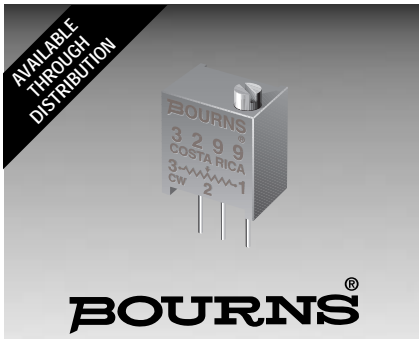

Features

- 3/8" Square/ Multiturn / Cermet / Industrial / Sealed
- Five popular terminal styles
- Standoffs
- Patent #4427966 drive mechanism

3299 - 3/8" Square Trimming Potentiometer

Electrical Characteristics

Standard Resistance Range 10 to 2 megohms
 (see standard resistance table)
 Resistance Tolerance ±10% std.
 (tighter tolerance available)
 Absolute Minimum Resistance 1% or 2 ohms max.
 (whichever is greater)
 Contact Resistance Variation 1.0% or 3 ohms max.
 (whichever is greater)
 Adjustability
 Voltage ±0.01%
 Resistance ±0.05%
 Resolution Infinite
 Insulation Resistance 500 vdc.
 1,000 megohms min.
 Dielectric Strength
 Sea Level 900 vac
 70,000 Feet 350 vac
 Effective Travel 25 turns nom.

Environmental Characteristics

Power Rating (300 volts max.)
 70°C 0.5 watt
 125°C 0 watt
 Temperature Range -55°C to +125°C
 Temperature Coefficient ±100ppm/°C
 Seal Test 85°C Fluorinert*
 Humidity MIL-STD-202 Method 103
 96 hours
 (2% ΔTR, 10 Megohms IR)
 Vibration 20G (1% ΔTR; 1% ΔVR)
 Shock 100G (1% ΔTR; 1% ΔVR)
 Load Life
 1,000 hours 0.5 watt @ 70°C
 (3% ΔTR; 3% or 3 ohms,
 whichever is greater, CRV)
 Rotational Life 200 cycles
 (4% ΔTR; 3% or 3 ohms,
 whichever is greater, CRV)

Physical Characteristics

Torque 3.0 oz-in. max.
 Mechanical Stops Wiper idles
 Terminals Solderable pins
 Weight 0.035 oz.
 Marking Manufacturer's
 trademark, resistance code,
 wiring diagram, date code,
 manufacturer's model
 number and style
 Wiper Set at CW end
 Flammability U.L. 94V-0
 Standard Packaging 50 pcs. per tube
 Adjustment Tool H-90

3299P

Common Dimensions

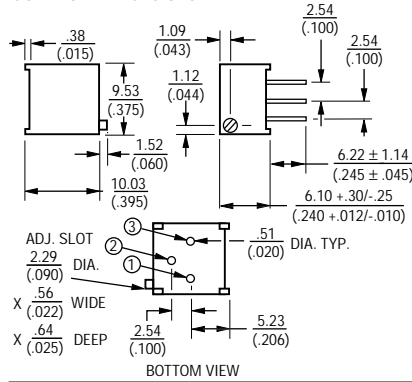

3299W

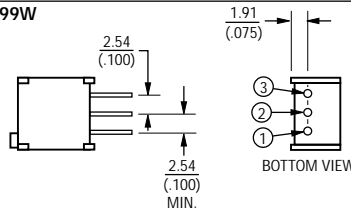

3299X

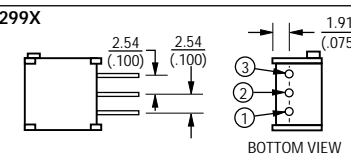

3299Y

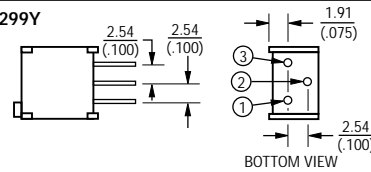

3299Z

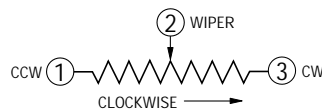
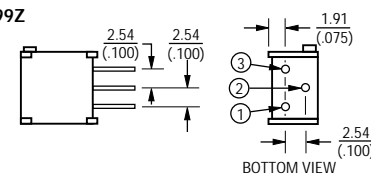

TOLERANCES: ± 0.25 (.010) EXCEPT WHERE NOTED

DIMENSIONS ARE: $\frac{\text{METRIC}}{\text{(INCHES)}}$

Standard Resistance Table

| Resistance (Ohms) | Resistance Code |
|-------------------|-----------------|
| 10 | 100 |
| 20 | 200 |
| 50 | 500 |
| 100 | 101 |
| 200 | 201 |
| 500 | 501 |
| 1,000 | 102 |
| 2,000 | 202 |
| 5,000 | 502 |
| 10,000 | 103 |
| 20,000 | 203 |
| 25,000 | 253 |
| 50,000 | 503 |
| 100,000 | 104 |
| 200,000 | 204 |
| 250,000 | 254 |
| 500,000 | 504 |
| 1,000,000 | 105 |
| 2,000,000 | 205 |

Popular values listed in boldface. Special resistances available.

How To Order

Model 3299 W - 1 - 103
 Style _____
 Standard or Modified _____
 Product Indicator _____
 -1 = Standard Product
 Resistance Code _____
 Consult factory for other available options.

*"FLUORINERT" IS A REGISTERED TRADEMARK OF 3M CO.

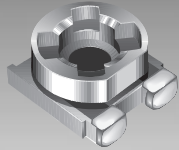

BOURNS®

Features

- Single-Turn Cermet / Open Frame
- Recommended for reflow processing
- Rotor design compatible with automatic adjustment equipment
- Supplied in 8mm embossed tape, compatible with automatic assembly equipment

- 2mm size meets EIA/EIAJ standard trimmer footprint

3302 - 2mm SMD Trimming Potentiometer

Electrical Characteristics

Standard Resistance Range200 to 1 megohm
 (see standard resistance table)
 Resistance Tolerance±25% std.
 Absolute Minimum Resistance
 ≤1K20 ohms max.
 >1K5% max.
 Contact Resistance Variation
5% max.
 ResolutionInfinite
 Adjustment Angle260° ±20°

Environmental Characteristics

Power Rating (50 VDC max.)
 70°C0.15 watt
 Temperature Range
-40°C to +85°C
 Temperature Coefficient
±250ppm/°C
 Humidity95%RH
 500 hours
 TRS max.±5%
 Load Life
@ 70°C rated power 500 hours
 TRS ±5%
 Rotational Cycling10 turns
 TRS ±15%

Physical Characteristics

Torque10-150g-cm max.
 Mechanical AngleContinuous
 MarkingPart marking code
 Standard Packaging
2000 pcs./7" reel
 Adjustment ToolH-91

*FLUORINERT® IS A REGISTERED TRADEMARK OF 3M CO.

How To Order

3302 X - 2 - 103 E

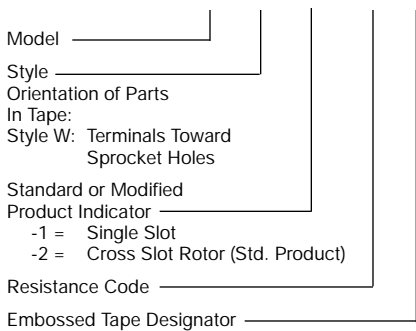

Consult factory for other available options.

**3302W, X-1
2mm Open Frame
for Reflow Soldering**

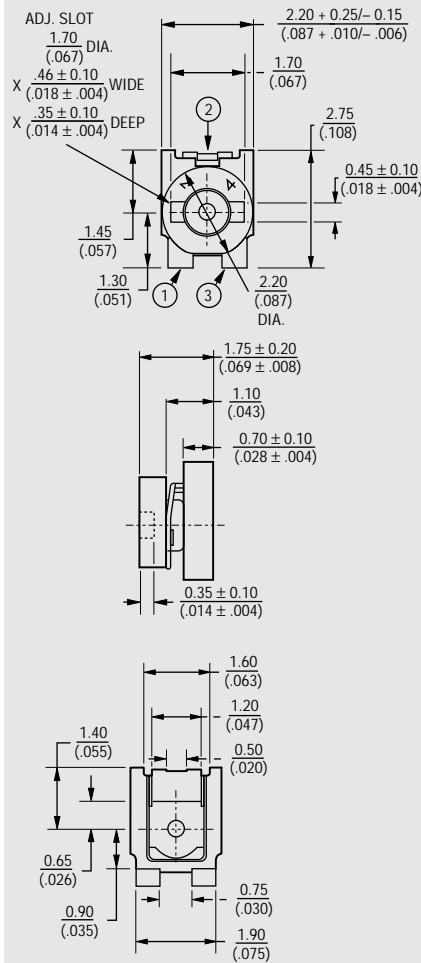

SUGGESTED PWB LAYOUT

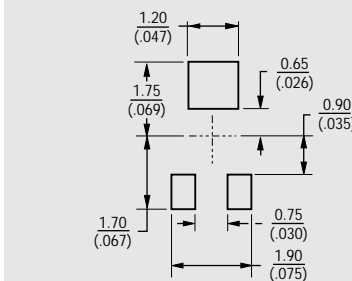

**3302W, X-2
3 Terminals for
Automatic Trimming Adjustment**

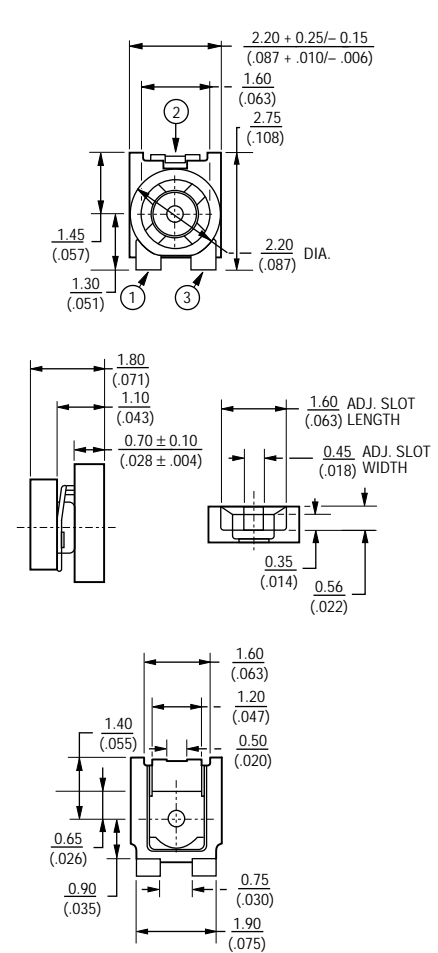

SUGGESTED PWB LAYOUT

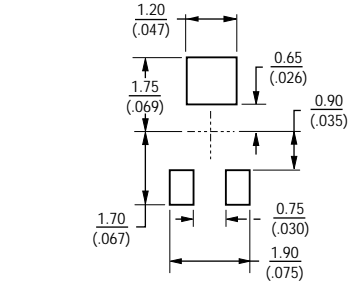

SHADED AREAS TYPICALLY NOT STOCKED BY DISTRIBUTORS AND NOT RECOMMENDED FOR NEW DESIGNS.

3302 - Packaging Specifications

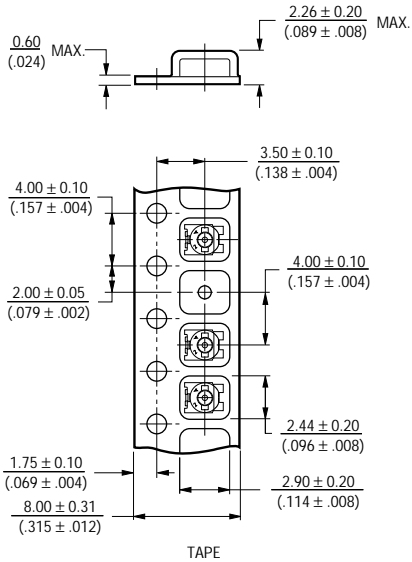

Standard Resistance Table

| Resistance (Ohms) | Part Marking Code | Resistance Code |
|-------------------|-------------------|-----------------|
| 200 | 22 | 201 |
| 500 | 52 | 501 |
| 1,000 | 13 | 102 |
| 2,000 | 23 | 202 |
| 5,000 | 53 | 502 |
| 10,000 | 14 | 103 |
| 20,000 | 24 | 203 |
| 50,000 | 54 | 503 |
| 100,000 | 15 | 104 |
| 200,000 | 25 | 204 |
| 500,000 | 55 | 504 |
| 1,000,000 | 16 | 105 |

Popular values listed in boldface.

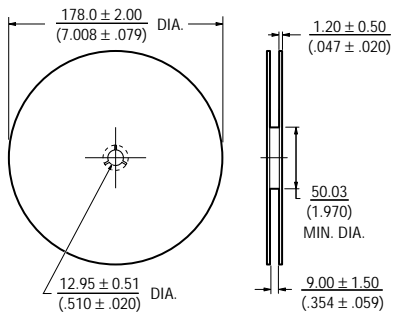

Meets EIA 481

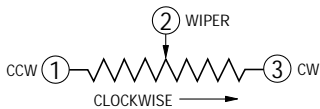

TOLERANCES: ± 0.25 (.010) EXCEPT WHERE NOTED

DIMENSIONS ARE: $\frac{\text{METRIC}}{\text{(INCHES)}}$

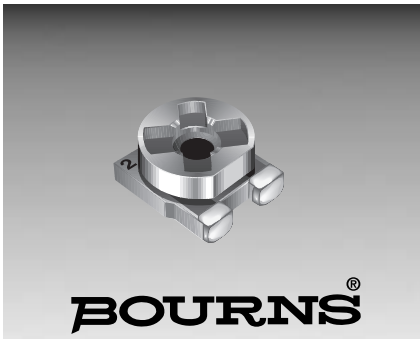

Features

- Recommended for reflow processing
- Rotor design compatible with pick and place and automatic adjustment equipment
- Supplied in 8mm embossed tape, compatible with automatic assembly equipment

- Rear adjust version available
- 3mm size meets EIA/EIAJ standard trimmer footprint

3303 - 3mm SMD Trimming Potentiometer

Electrical Characteristics

Standard Resistance Range100 to 1 megohm
 (see standard resistance table)
 Resistance Tolerance±25% std.
 Absolute Minimum Resistance
 ≤ 1K Ohms20 ohms max.
 >1K Ohms2% max. of TR
 Contact Resistance Variation ...5% max.
 ResolutionInfinite
 Adjustment Angle260° ±20°

Environmental Characteristics

Resistance to Soldering Heat
260°C, 10 seconds, TRS max. 5%
 Power Rating (50 VDC max.)
 70°C0.15 watt
 Temperature Range
-40°C to +125°C
 Temperature Coefficient
±250ppm/°C
 Humidity95%RH
 500 hours
 TRS max.±5%
 Load Life
@ 70°C rated power 500 hours
 TRS ±5%
 Rotational Cycling20 turns
 TRS ±15%

Physical Characteristics

Torque20-200g-cm max.
 Mechanical AngleContinuous
 MarkingPart marking code
 Standard Packaging
2000 pcs./7" reel
 Adjustment ToolH-90

How To Order

3303 X - 3 - 103 E

Model _____
 Style _____
 Orientation of Parts In Tape:
 Styles W, C - Terminals Toward Sprocket Holes
 Styles X, D - Terminals Away From Sprocket Holes (preferred)
 Standard or Modified Product Indicator
 -1 = Single Slot
 *-2 = Cross Slot Rotor (Optional)
 -3 = Cross Slot Low Profile (Standard)
 Resistance Code _____
 Embossed Tape Designator _____
 Consult factory for other available options.
 *Not available in C and D styles

3303W, X-1
 3mm Open Frame
 for Reflow Soldering
 3-Terminal

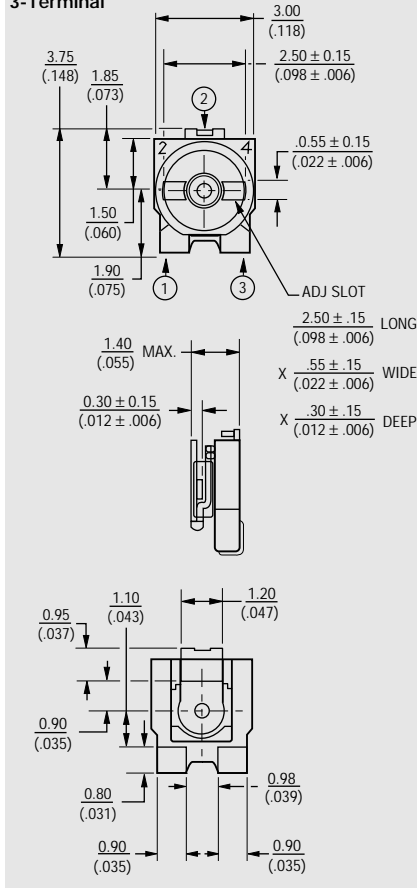

3303W, X-3
 3mm Open Frame
 for Reflow Soldering
 3-Terminal
 Low Profile

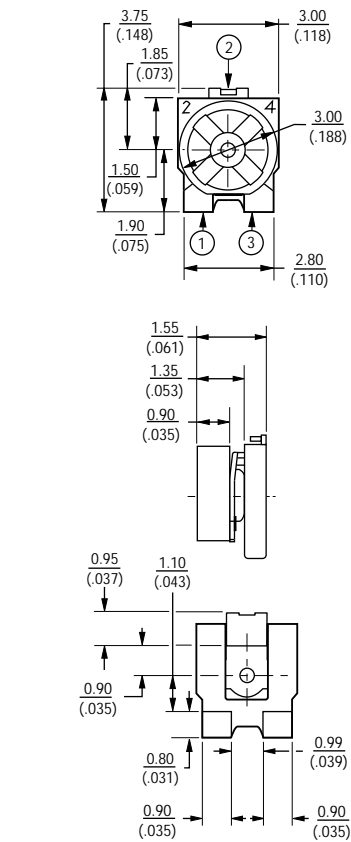

SUGGESTED PWB LAYOUT

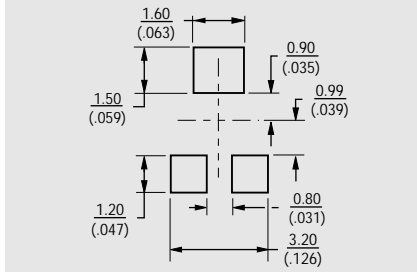

TOLERANCES: ± 0.30 (.012) EXCEPT WHERE NOTED

DIMENSIONS ARE: METRIC (INCHES)

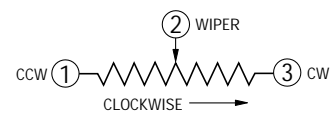

SHADED AREAS TYPICALLY NOT STOCKED BY DISTRIBUTORS AND NOT RECOMMENDED FOR NEW DESIGNS.

3303 - Dimensions and Tolerances



3303W, X-2
3mm Open Frame
for Reflow Soldering
3-Terminal (OPTIONAL)

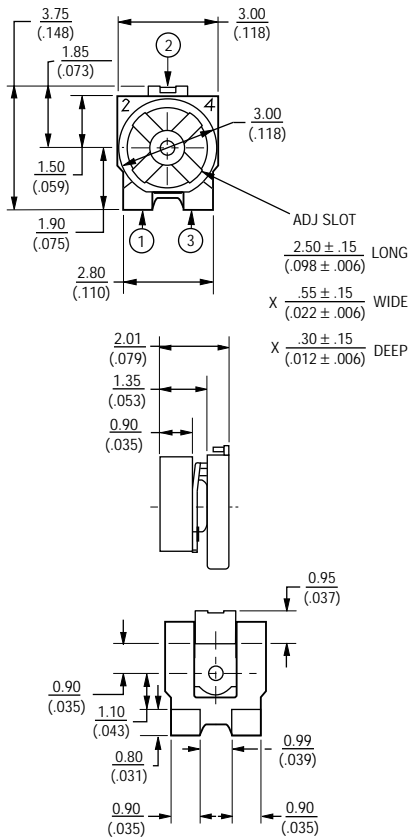

SUGGESTED PWB LAYOUT

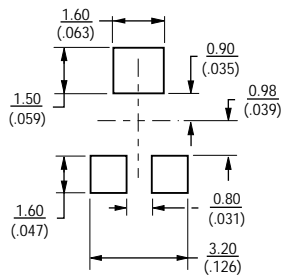

TOLERANCES: ± 0.30 (.012) EXCEPT WHERE NOTED

DIMENSIONS ARE: METRIC (INCHES)

3303C,D
3-Terminal
Both Sides Adjust
(OPTIONAL)

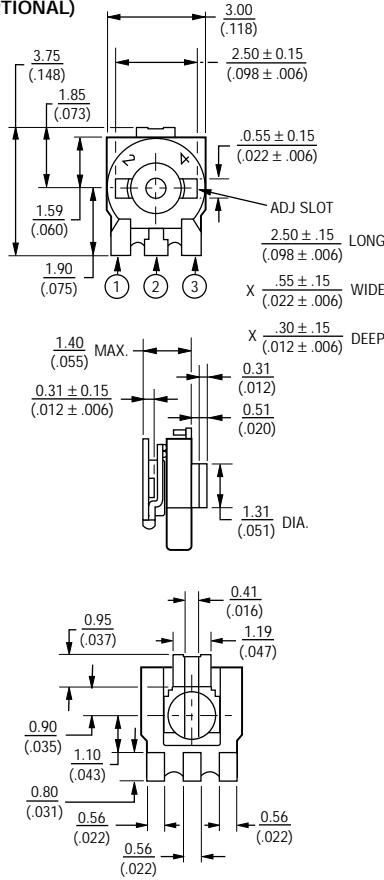

SUGGESTED PWB LAYOUT

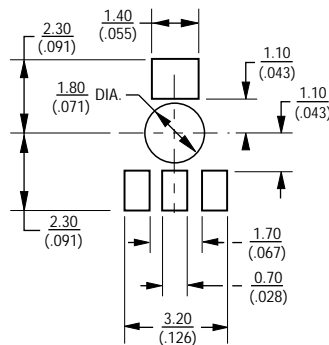

TOLERANCES: ± 0.38 (.015) EXCEPT WHERE NOTED

DIMENSIONS ARE: METRIC (INCHES)

Packaging Specifications

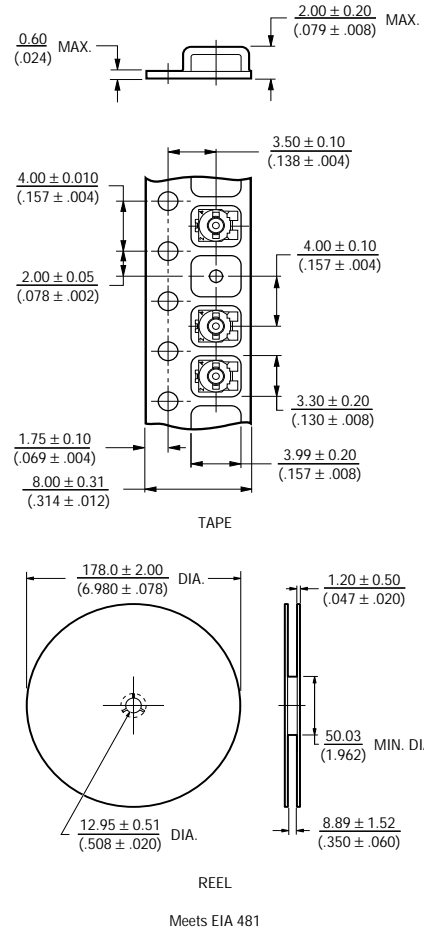

TOLERANCES: ± 0.25 (.010) EXCEPT WHERE NOTED

DIMENSIONS ARE: METRIC (INCHES)

Standard Resistance Table

| Resistance (Ohms) | Part Marking Code | Resistance Code |
|-------------------|-------------------|-----------------|
| 100 | 12 | 101 |
| 200 | 22 | 201 |
| 500 | 52 | 501 |
| 1,000 | 13 | 102 |
| 2,000 | 23 | 202 |
| 5,000 | 53 | 502 |
| 10,000 | 14 | 103 |
| 20,000 | 24 | 203 |
| 50,000 | 54 | 503 |
| 100,000 | 15 | 104 |
| 200,000 | 25 | 204 |
| 500,000 | 55 | 504 |
| 1,000,000 | 16 | 105 |

Popular values listed in boldface.

SHADED AREAS TYPICALLY NOT STOCKED BY DISTRIBUTORS AND NOT RECOMMENDED FOR NEW DESIGNS.



Features

- 6mm Round / Single-Turn / Cermet Industrial / Open Frame
- Cross slot adjustment options
- Horizontal and vertical mounting styles
- Dust resistant/splash resistant covers
- PC board stand-offs and retention feature

- Front and top adjust styles

3306 - 6mm Round Trimming Potentiometer

Electrical Characteristics

Standard Resistance Range100 to 1 megohm
 (see standard resistance table)
 Resistance Tolerance±25% std.
 Absolute Minimum Resistance2% max. ($\leq 2K = 30$ ohms)
 Contact Resistance Variation ...3% max.
 Resolution.....Infinite
 Adjustment Angle215° nom.

Environmental Characteristics

Power Rating (100 volts max.)
 70°C0.2 watt
 Temperature Range-25°C to +100°C
 Temperature Coefficient±250ppm/°C
 Load Life ..1,000 hours 0.2 watt @ 70°C
 (5% ΔTR)

Physical Characteristics

Mechanical Angle.....260° ±20°
 Torque (Operating).....4.5 oz-in. max.
 Stop Strength6.5 oz-in. min.
 TerminalsSolderable pins
 MarkingManufacturer's trademark, resistance code
 Standard Packaging300 pcs. per bag
 Adjustment ToolH-90
 Aqueous cleaning not recommended

How To Order

Model _____ **3306 W - 1 - 103**
 Style _____
 Standard Product _____
 Resistance Code _____

Standard Resistance Table

| Resistance (Ohms) | Resistance Code |
|-------------------|-----------------|
| 100 | 101 |
| 200 | 201 |
| 500 | 501 |
| 1,000 | 102 |
| 2,000 | 202 |
| 5,000 | 502 |
| 10,000 | 103 |
| 20,000 | 203 |
| 25,000 | 253 |
| 50,000 | 503 |
| 100,000 | 104 |
| 200,000 | 204 |
| 250,000 | 254 |
| 500,000 | 504 |
| 1,000,000 | 105 |

Popular values listed in boldface. Special resistances available.

SHADED AREA NOT TYPICALLY STOCKED BY DISTRIBUTORS AND NOT RECOMMENDED FOR NEW DESIGNS.

Top Adjust Common Dimensions

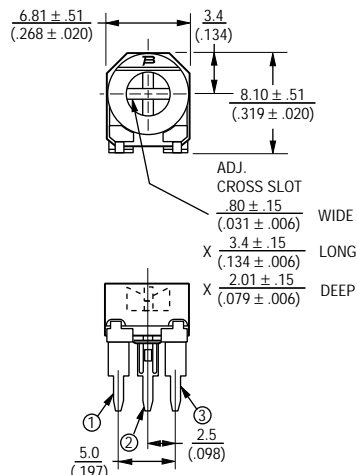

3306W

Side Adjust Common Dimensions

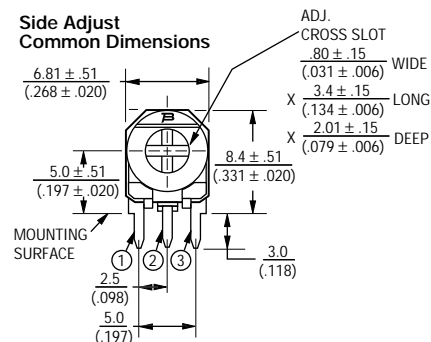

3306W

3306P

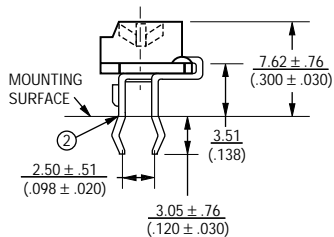

3306F

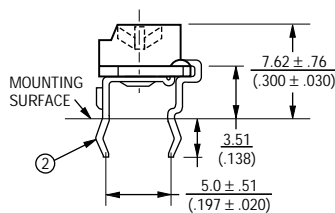

SUGGESTED PWB LAYOUT - STYLE F

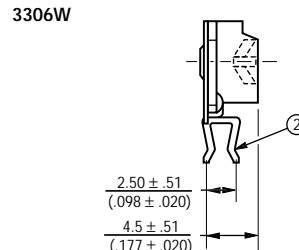
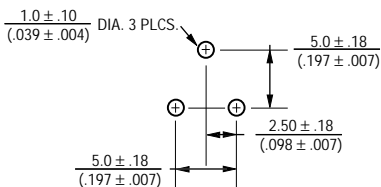

3306K

SUGGESTED PWB LAYOUT - STYLES K, P, W

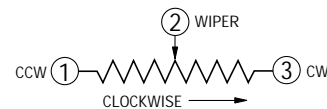
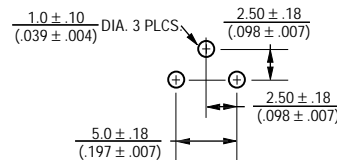

TOLERANCES: ± 0.25 (.010) EXCEPT WHERE NOTED

DIMENSIONS ARE: METRIC (INCHES)



Features

- 9mm Round / Single-Turn / Cermet Industrial / Open Frame
- Both sides adjust
- Cross slot and hexagon adjustment designs
- Horizontal and vertical mounting styles
- Dust resistant/splash resistant covers
- PC board stand-offs and retention feature

3309 - 9mm Round Trimming Potentiometer

Electrical Characteristics

Standard Resistance Range100 to 2 megohms
 (see standard resistance table)
 Resistance Tolerance±25% std.
 Absolute Minimum Resistance2% max. (≤2K = 30 ohms)
 Contact Resistance Variation ...3% max.
 Resolution.....Infinite
 Adjustment Angle235° nom.

Environmental Characteristics

Power Rating (250 volts max.)
 70°C0.5 watt
 Temperature Range-25°C to +100°C
 Temperature Coefficient±250ppm/°C
 Load Life1,000 hours 0.5 watt
 @ 70°C (5% ΔTR)

Physical Characteristics

Mechanical Angle260°±20°
 Torque (Operating)5 oz-in. max.
 Stop Strength11.0 oz -in. min.
 TerminalsSolderable pins
 MarkingManufacturer's trademark, resistance code
 Standard Packaging200 pcs. per bag
 Adjustment ToolH-90
 Aqueous cleaning not recommended

How To Order

3309 W - 2 - 103

Model _____
 Pin Style _____
 Rotor Style _____
 -2 = Cross Slot/Single Slot Rear Adjust
 -3 = 2mm Hex Thru Hole
 Resistance Code _____

Top/Bottom Adjust Common Dimensions 3309P

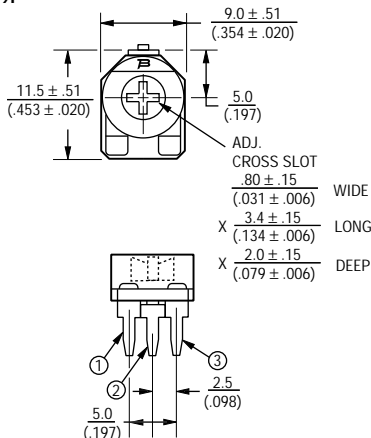

3309P-3 Both Sides Adjust Hex

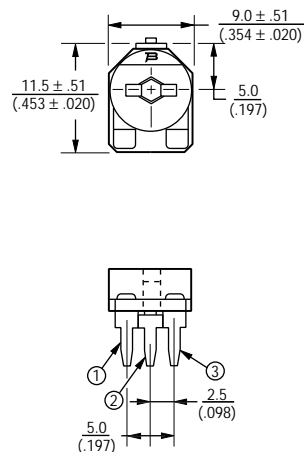

3309P-1 Top Adjust

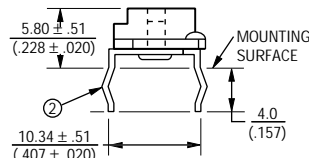
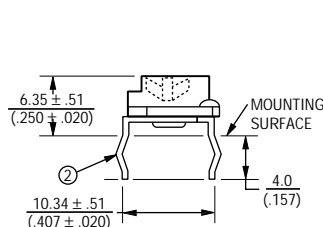

3309P-2 Both Sides Adjust/Cross Slot

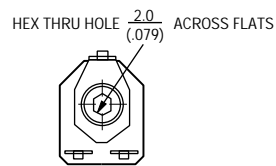
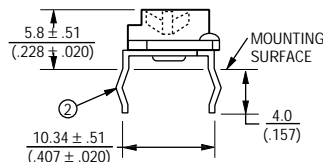

SUGGESTED PWB LAYOUT - 3309P

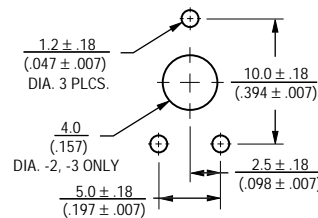

TOLERANCES: ± 0.25 (.010) EXCEPT WHERE NOTED

DIMENSIONS ARE: $\frac{\text{METRIC}}{\text{(INCHES)}}$

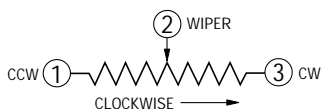

3309 - 9mm Round Trimming Potentiometer

BOURNS®

Side Adjust Common Dimensions 3309W

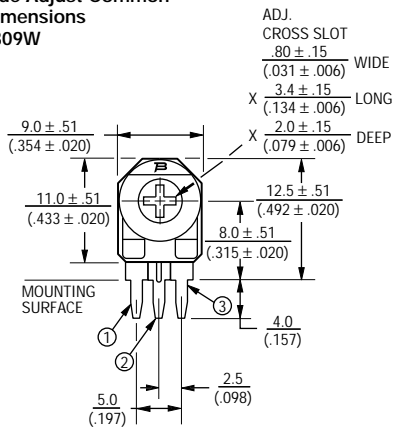

3309W-3 Both Sides Adjust Hex

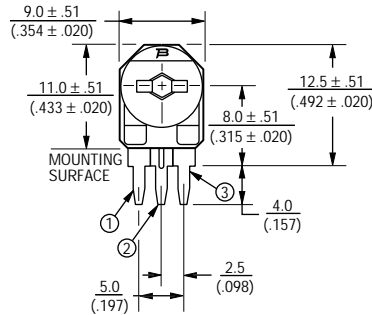

Standard Resistance Table

| Resistance (Ohms) | Resistance Code |
|-------------------|-----------------|
| 100 | 101 |
| 200 | 201 |
| 500 | 501 |
| 1,000 | 102 |
| 2,000 | 202 |
| 5,000 | 502 |
| 10,000 | 103 |
| 20,000 | 203 |
| 25,000 | 253 |
| 50,000 | 503 |
| 100,000 | 104 |
| 200,000 | 204 |
| 250,000 | 254 |
| 500,000 | 504 |
| 1,000,000 | 105 |
| 2,000,000 | 205 |

Popular values listed in boldface. Special resistances available.

SHADED AREA NOT TYPICALLY STOCKED BY DISTRIBUTORS AND NOT RECOMMENDED FOR NEW DESIGNS.

3309W-1 Single Side (Front) Adjust

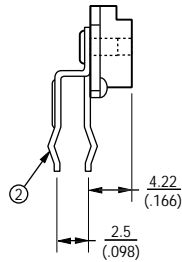
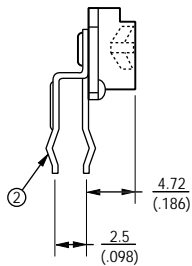

HEX THRU HOLE 2.01 (.079) ACROSS FLATS



3309W-2 Both Sides Adjust - Cross Slot

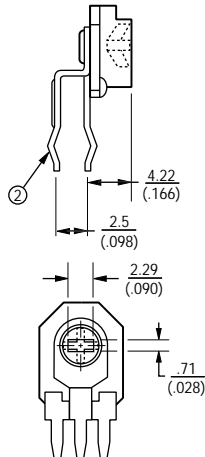

SUGGESTED PWB LAYOUT - 3309W

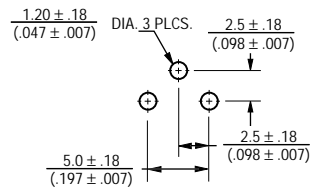



Features

- Surface Mount 3mm Square Single-Turn Cermet / Sealed
- Compatible with surface mount manufacturing processes
- Rotor stop for "in-circuit" adjustment
- 100 cycle rotational and seal life

- Patent #5043695 assembly for seal integrity
- Plastic housing for RF applications

3313 - 3mm Trimming Potentiometer

Electrical Characteristics

Standard Resistance Range
10 ohms to 2 megohms
 (see standard resistance table)
 Resistance Tolerance±20% std.
 End Resistance1% or 3 ohms max.
 (whichever is greater)
 Contact Resistance Variation
3% or 3 ohms
 Adjustability
 Voltage Divider±0.1%
 Rheostat±0.2%
 ResolutionInfinite
 Insulation Resistance500 vdc.
 100 megohms min.
 Dielectric Strength
 Sea Level500 vac
 70,000 Feet350 vac
 Adjustment Angle220° nom.

Environmental Characteristics

Max. Soldering Exposure
260°C/5 seconds
 Power Rating (200 volts max.)
 70°C0.125 watt
 125°C0 watt
 Operating Temp. Range...-55°C to +125°C
 Temperature Coefficient
≤100 ohms ±150ppm/°C;
 >100 ohms ±100ppm/°C
 Seal Test85°C Fluorinert*
 HumidityMIL-STD 202, Method 106
 (no vibration) TRS ±3%;
 IR 10 megohms
 Vibration20G TRS ±1%; VRS ±1%
 Shock100G TRS ±1%; VRS ±1%
 Load Life1000 hours
 @ 70°C Rated Power; TRS ±3%
 Rotational Life100 cycles TRS ±3%
 Thermal Shock5 cycles
 TRS ±2%; VRS ±1%

Physical Characteristics

Mechanical Angle250° nom.
 Torque50g-cm max.
 Stop Strength200g-cm min.
 Pushover Strength ("S" only)
1.6 Kilograms (3.5 lbs) minimum
 FlammabilityU.L. 94V-0
 WeightApprox. 0.01 oz.
 MarkingResistance code
 and date code
 WiperSet at 50% nominal
 Standard Packaging1000 pcs./7" reel
 Adjustment ToolH-91

*"FLUORINERT" IS A REGISTERED TRADEMARK OF 3M CO.

3313J

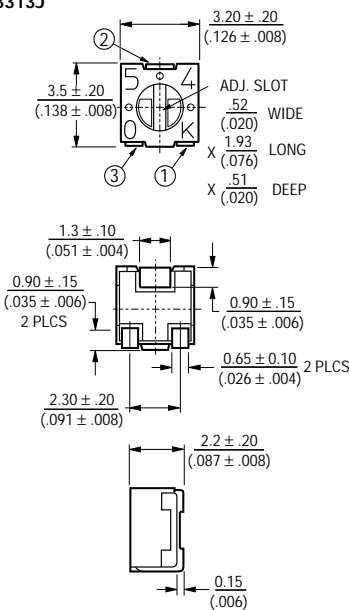

RECOMMENDED LAND PATTERN

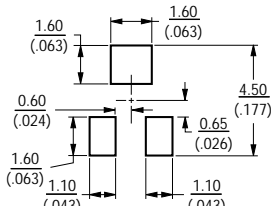

TOLERANCES: ± 0.25 (.010) EXCEPT WHERE NOTED

DIMENSIONS ARE: METRIC (INCHES)

How To Order

Model **3313 J - 1 - 502 E**
 Style _____
 Standard or Modified Product Indicator _____
 -1 = Standard Product
 Resistance Code _____
 Embossed Tape _____
 1000 pcs. / 7" Reel (Standard)

3313S

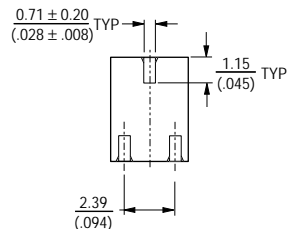
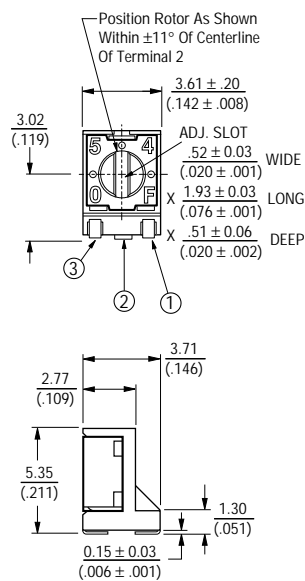

RECOMMENDED LAND PATTERN

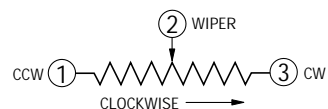
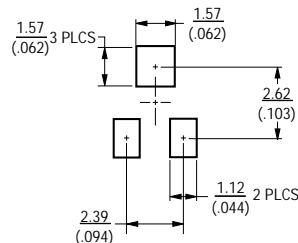

3313 - 3mm Trimming Potentiometer



3313 Packaging Specifications

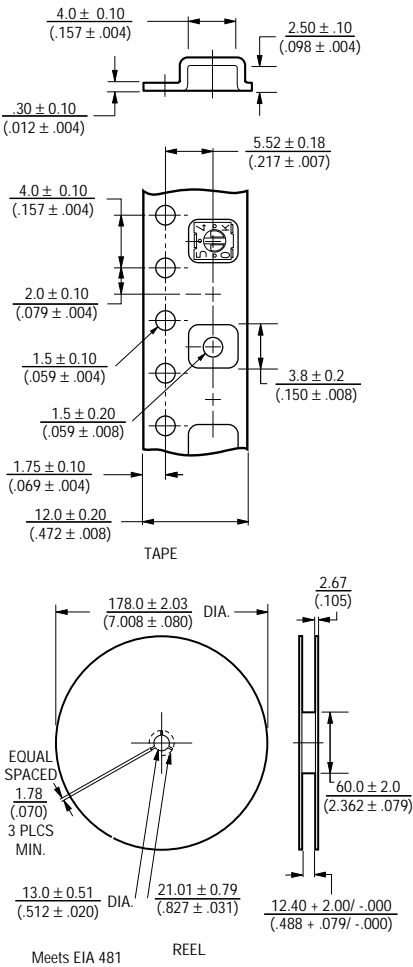

TOLERANCES: ± 0.25 (.010) EXCEPT WHERE NOTED

DIMENSIONS ARE: $\frac{\text{METRIC}}{\text{(INCHES)}}$

3313S Packaging Specifications

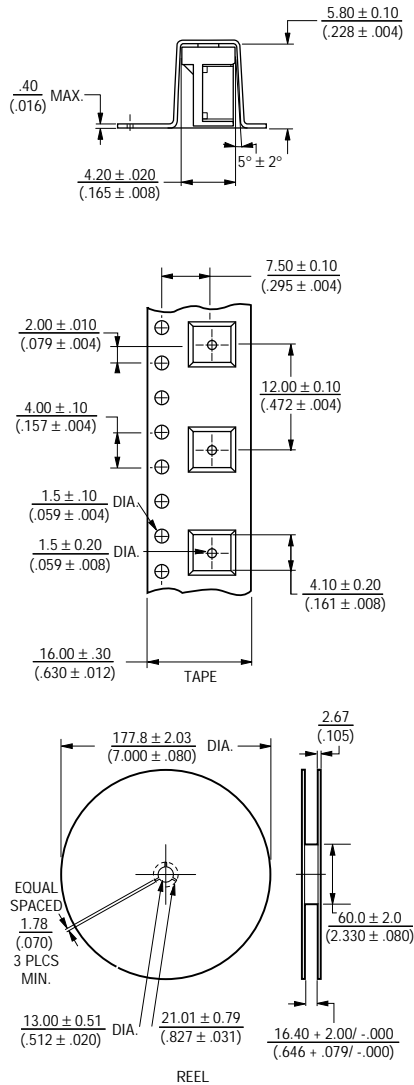

Standard Resistance Table

| Resistance (Ohms) | Part Marking Code | Resistance Code |
|-------------------|-------------------|-----------------|
| 10 | A1 | 100 |
| 20 | 21 | 200 |
| 50 | 51 | 500 |
| 100 | A2 | 101 |
| 200 | 22 | 201 |
| 500 | 52 | 501 |
| 1,000 | A3 | 102 |
| 2,000 | 23 | 202 |
| 5,000 | 53 | 502 |
| 10,000 | A4 | 103 |
| 20,000 | 24 | 203 |
| 50,000 | 54 | 503 |
| 100,000 | A5 | 104 |
| 200,000 | 25 | 204 |
| 500,000 | 55 | 504 |
| 1,000,000 | A6 | 105 |
| 2,000,000 | 26 | 205 |

Popular values listed in boldface. Special resistances available.

SHADED AREA NOT TYPICALLY STOCKED BY DISTRIBUTORS AND NOT RECOMMENDED FOR NEW DESIGNS.

AVAILABLE THROUGH DISTRIBUTION



BOURNS®

Features

- Surface Mount / Single Turn / Cermet Industrial / Sealed
- Compatible with surface mount manufacturing processes
- Compatible with popular vacuum pick-and-place equipment

- J-hook, gull-wing and pinned configurations
- Side adjust available
- Cross-slot rotor (Z Style)
- Meets EIA/EIAJ/IPC/VRCI SMD standard trimmer designs

3314 - 4mm Square Trimming Potentiometer

Electrical Characteristics

Standard Resistance Range10 ohms to 2 megohms (see standard resistance table)
 Resistance Tolerance±20% std. (tighter tolerance available)
 End Resistance.....1% or 2 ohms max. (whichever is greater)
 Contact Resistance Variation1% or 3 ohms
 Resolution.....Infinite
 Insulation Resistance500 vdc. 100 megohms min.
 Dielectric Strength
 Sea Level.....500 vac (1 minute)
 Adjustment Angle210° nom.

Environmental Characteristics

Soldering Heat260°C, 10 seconds, TRS ±1%
 Power Rating (300 volts max.)
 70°C.....0.25 watt
 125°C.....0 watt
 Temperature Range-55°C to +125°C
 Temperature Coefficient±100ppm/°C
 Humidity90-98% RH, 10 cycles, 240 hours
 Vibration20G TRS ±1%; VRS ±1%
 Shock100G TRS ±1%; VRS ±1%
 Load Life
(@ 70°C Rated Power 1000 Hours) TRS ±3%
 Rotational Life100 cycles TRS ±3%
 Thermal Shock5 cycles TRS ±2%; VRS ±1%

Physical Characteristics

Mechanical Angle240° nom.
 Torque180g-cm typical
 Stop Strength300g-cm typical
 Pushover Strength (Z Style)2 kilograms (4.4 lbs.) minimum
 WeightApproximately 0.01 oz.
 MarkingManufacturer's code, resistance code and date code
 WiperPositioned at 50% nominal
 Flammability.....U.L. 94V-0
 Standard Packaging
 J & G500 pcs./7" reel
 Z200 pcs./7" reel
 H50 pcs./tube
 Adjustment ToolH-90

3314J-1

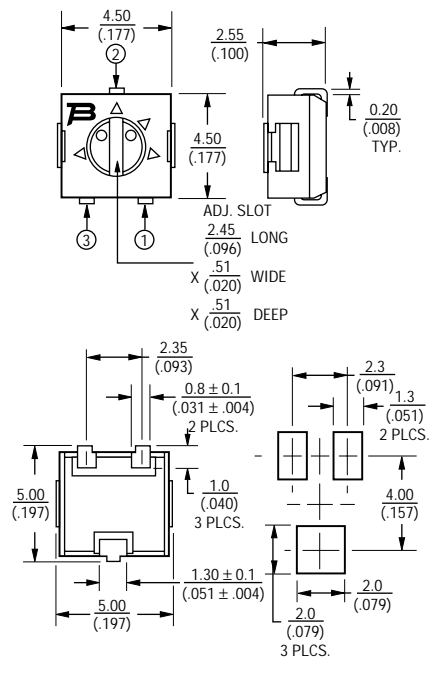

3314G-1

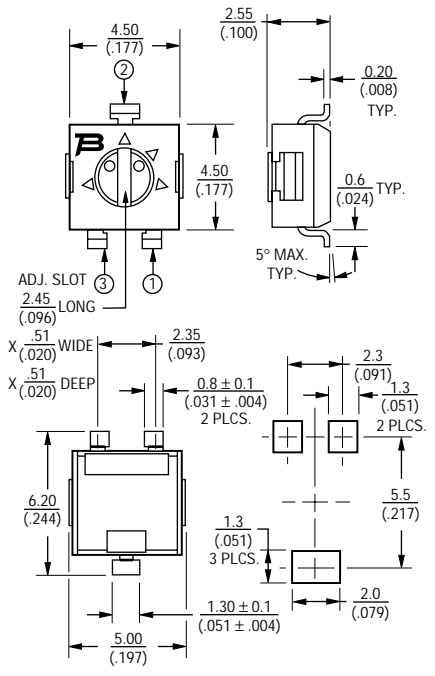

3314R-1

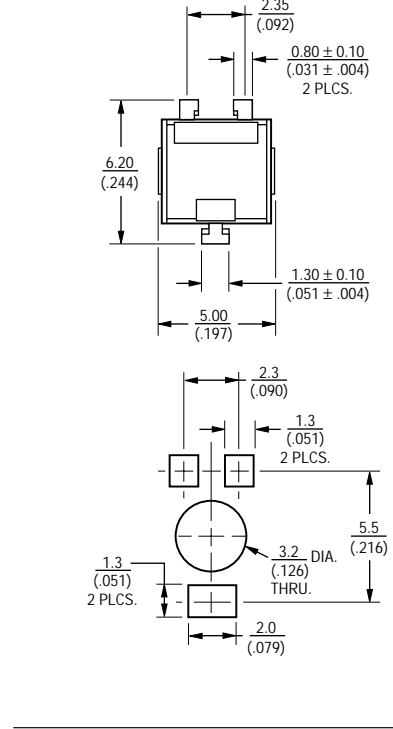
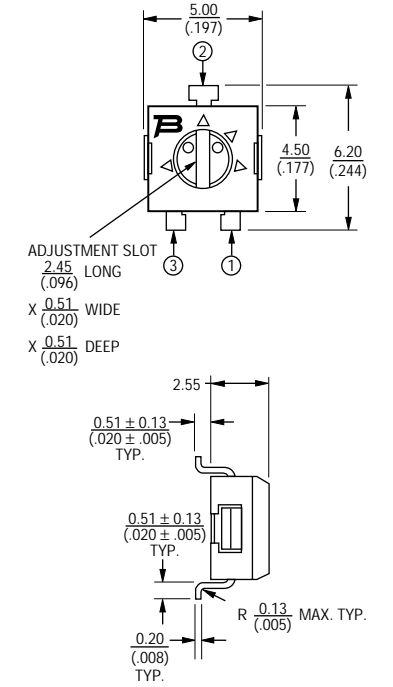

DIMENSIONS ARE: METRIC (INCHES)

Additional Features

- Model 3314 has been approved for use by DESC on drawings 88039 (3314J) and 90027 (3314G)

3314 - 4mm Square Trimming Potentiometer



3314H-1

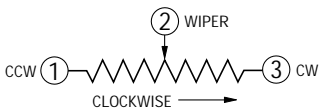
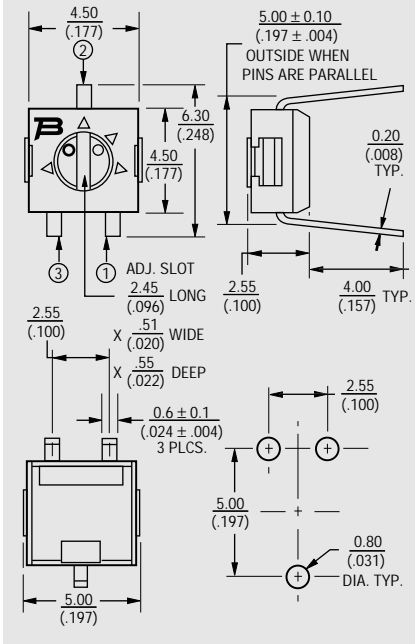

TOLERANCES: ± 0.25 (.010) EXCEPT WHERE NOTED

DIMENSIONS ARE: METRIC (INCHES)

SHADED AREAS TYPICALLY NOT STOCKED BY DISTRIBUTORS AND NOT RECOMMENDED FOR NEW DESIGNS.

How To Order

3314 J - 1 - 502 E

- Model _____
 - Style _____
 - Standard or Modified Product Indicator
 - 1 = Single Slot
 - 2 = Cross Slot Rotor (Style Z is standard, Styles J, G & H are available)
 - Resistance Code _____
 - Embossed Tape Designer (Applicable to Styles J, G and S only)
 - Styles J & G: 500 pcs. / 7" reel (standard)
 - Style Z: 200 pcs. / 7" reel (standard)
- Consult factory for other available options.

3314Z

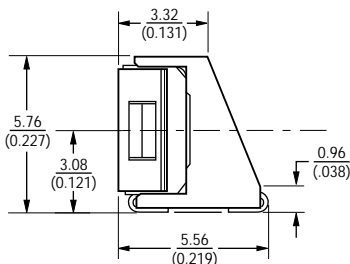
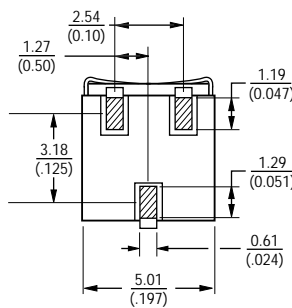
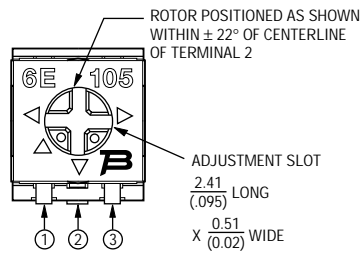

RECOMMENDED PCB LAYOUT

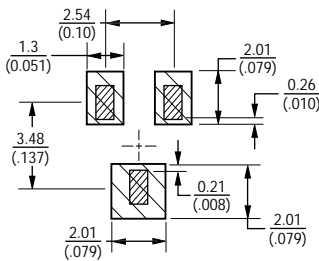

Packaging Specifications

(J, G Styles)

TAPE

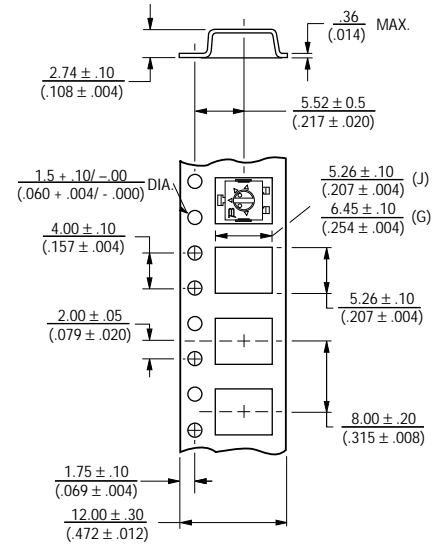

REEL

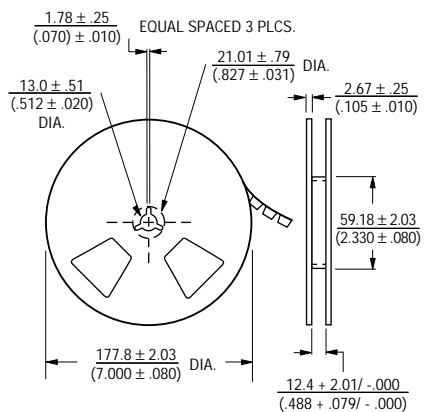

Meets EIA specification 481.

3314 - 4mm Square Trimming Potentiometer

BOURNS®

Packaging Specifications

(R Style)

TAPE

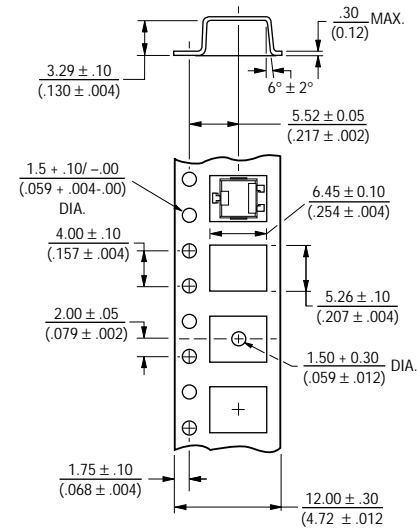

REEL

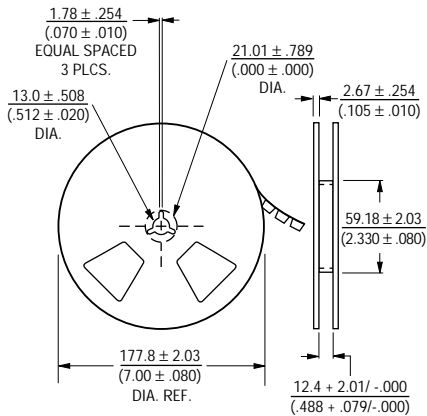

Meets EIA specification 481.

Packaging Specifications

(Z Style)

TAPE

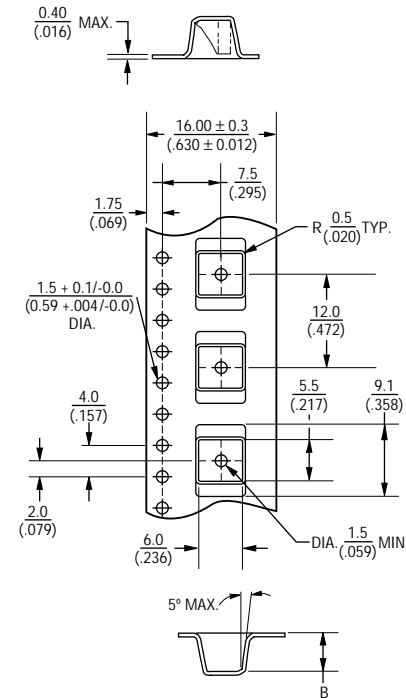

REEL

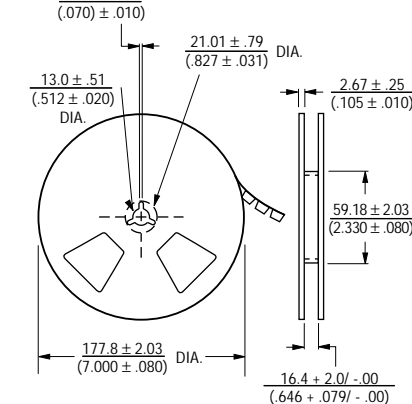

TOLERANCES: ± 0.30 (.012) EXCEPT WHERE NOTED

DIMENSIONS ARE: $\frac{\text{METRIC}}{\text{(INCHES)}}$

Standard Resistance Table

| Resistance (Ohms) | Resistance Code |
|-------------------|-----------------|
| 10 | 100 |
| 20 | 200 |
| 50 | 500 |
| 100 | 101 |
| 200 | 201 |
| 500 | 501 |
| 1,000 | 102 |
| 2,000 | 202 |
| 5,000 | 502 |
| 10,000 | 103 |
| 20,000 | 203 |
| 50,000 | 503 |
| 100,000 | 104 |
| 200,000 | 204 |
| 250,000 | 254 |
| 500,000 | 504 |
| 1,000,000 | 105 |
| 2,000,000 | 205 |

Popular values listed in boldface. Special resistances available.

SHADED AREAS TYPICALLY NOT STOCKED BY DISTRIBUTORS AND NOT RECOMMENDED FOR NEW DESIGNS.

AVAILABLE THROUGH DISTRIBUTION

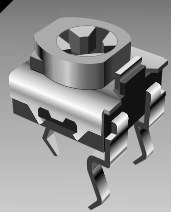

BOURNS®

Features

- Single-Turn / Carbon / Commercial Open Frame
- Cross slot rotor design suitable for automatic adjustment equipment
- Board retention feature
- Enclosed cover
- PC board stand-offs
- Adjustable front/back, top/bottom

3318 - 6mm Square Trimming Potentiometer

Electrical Characteristics

Standard Resistance Range100 to 1 megohm
 (see standard resistance table)
 Resistance Tolerance±30%
 Contact Resistance Variation10% max.
 Resolution.....Infinite
 Adjustment Angle.....210° ±20°

Environmental Characteristics

Power Rating
 100-500K ohms50V
 >500K ohms25V
 50°C0.1 watt
 Temperature Range-25°C to +100°C
 Temperature Coefficient ...±1000ppm/°C
 Load Life ...1,000 hours 0.1 watt @ 70°C
 (20% ΔTR)

Physical Characteristics

Torque (Operating).....20-250 g-cm
 Stop Strength
 Knob Side750 g-cm
 Reverse Side350g-cm
 TerminalsSolderable pins
 MarkingResistance code, date code
 Standard Packaging200 pcs. per bag
 Adjustment ToolH-90
 Aqueous cleaning not recommended

How To Order

3318 K - 1 - 103

Model _____
 Style _____
 Standard Product _____
 Resistance Code _____

Standard Resistance Table

| Resistance (Ohms) | Resistance Code |
|-------------------|-----------------|
| 100 | 101 |
| 200 | 201 |
| 500 | 501 |
| 1,000 | 102 |
| 2,000 | 202 |
| 5,000 | 502 |
| 10,000 | 103 |
| 20,000 | 203 |
| 50,000 | 503 |
| 100,000 | 104 |
| 200,000 | 204 |
| 500,000 | 504 |
| 1,000,000 | 105 |

Popular values listed in boldface.

SHADED AREAS TYPICALLY NOT STOCKED BY DISTRIBUTORS AND NOT RECOMMENDED FOR NEW DESIGNS.

3318K

FRONT VIEW

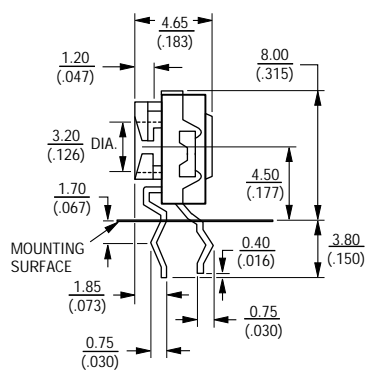
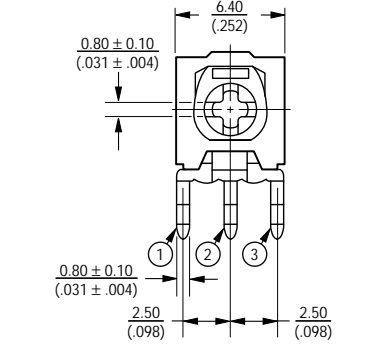

REAR VIEW

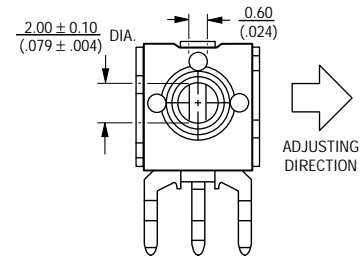

SUGGESTED PWB LAYOUT

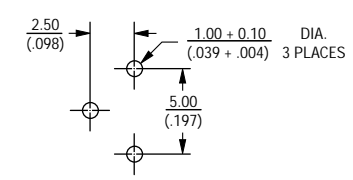

3318F

FRONT VIEW

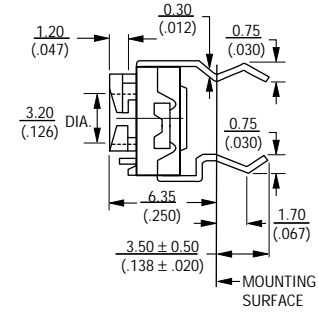
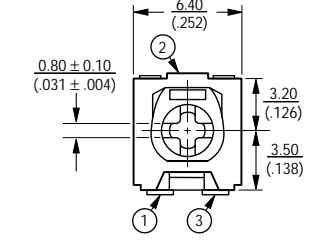

REAR VIEW

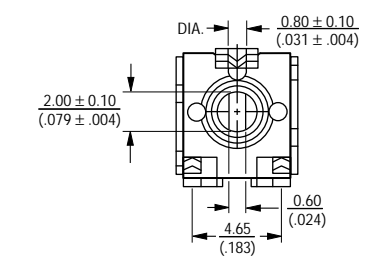

SUGGESTED PWB LAYOUT

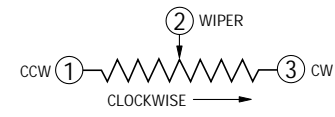
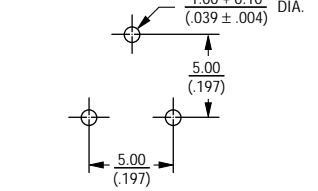

TOLERANCES: ± 0.25 (.010) EXCEPT WHERE NOTED

DIMENSIONS ARE: METRIC (INCHES)

Specifications are subject to change without notice.

AVAILABLE THROUGH DISTRIBUTION

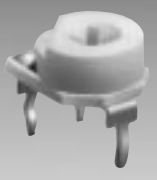

BOURNS®

Features

- 9mm Round / Single Turn / Carbon Commercial / Open Frame
- Both sides adjust
- Cross slot and hexagon adjustment designs
- Horizontal and vertical mounting styles

- Dust resistant/splash resistant covers
- PC board stand-offs and retention feature

3319 - 9mm Round Trimming Potentiometer

Electrical Characteristics

Standard Resistance Range100 to 1 megohm
 (see standard resistance table)
 Resistance Tolerance±25% std.
 End Resistance2% max. (≤2K = 30 ohms)
 Contact Resistance Variation3% max.
 Resolution.....Infinite
 Adjustment Angle235° nom.

Environmental Characteristics

Power Rating (200 volts max.)
 70°C0.2 watt
 Temperature Range-25°C to +100°C
 Temperature Coefficient±1000ppm/°C
 Load Life1,000 hours 0.2 watt @ 70°C
 (<100K = +3/-7% ΔTR)
 (≥100K = +3/-10% ΔTR)

Physical Characteristics

Torque (Operating)5 oz-in. max.
 Stop Strength11.0 oz-in. min.
 TerminalsSolderable pins
 MarkingManufacturer's trademark, resistance code
 Standard Packaging200 pcs. per bag
 Adjustment ToolH-90

Aqueous cleaning not recommended

How To Order

3319 W - 2 - 103

Model _____
 Pin Style _____
 Rotor Style _____
 -2 = Cross Slot/Single Slot Rear Adjust
 -3 = 2mm Hex Thru Hole
 Resistance Code _____

3319P Common Dimensions

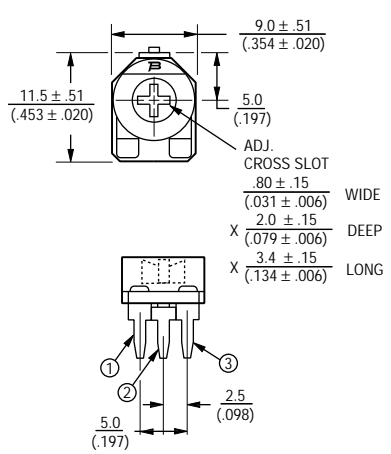

3319P-3 Both Sides Adjust/Hex

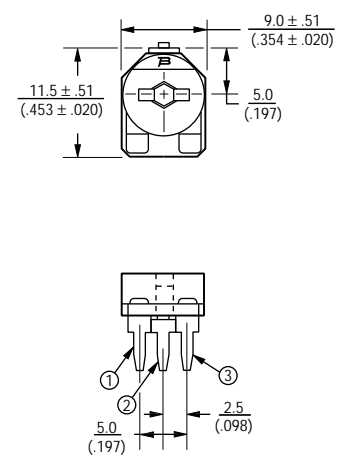

3319P-1 Top Adjust

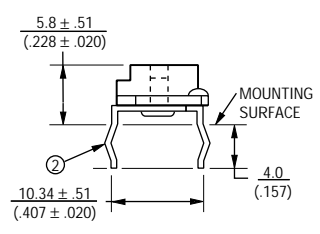
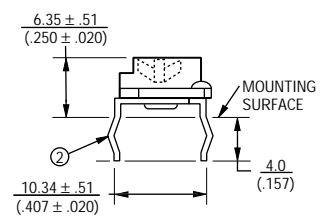

3319P-2 Both Sides Adjust/Cross Slot

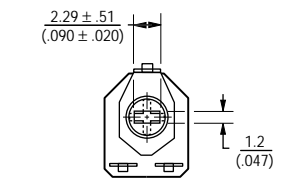
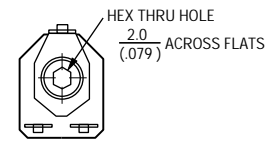
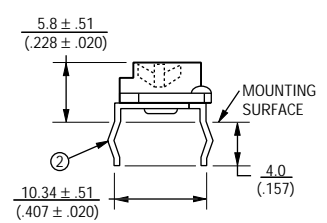

SUGGESTED PWB LAYOUT - 3319P

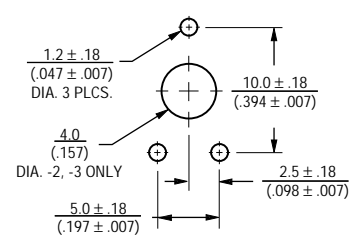

TOLERANCES: ± 0.25 (.010) EXCEPT WHERE NOTED

DIMENSIONS ARE: METRIC (INCHES)

3319 - 9mm Round Trimming Potentiometer



Side Adjust
3319W-1

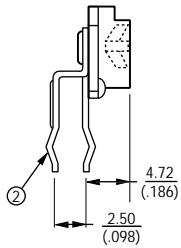
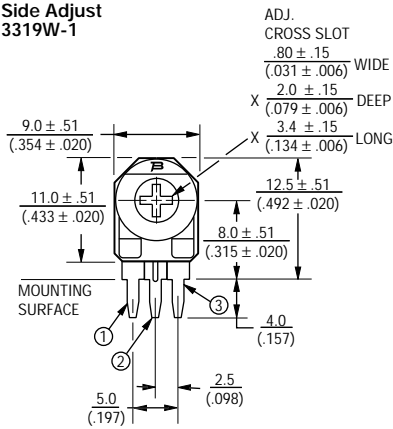

3319W-3 Both Sides Adjust/Hex

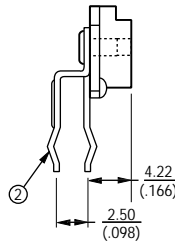
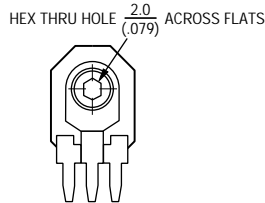
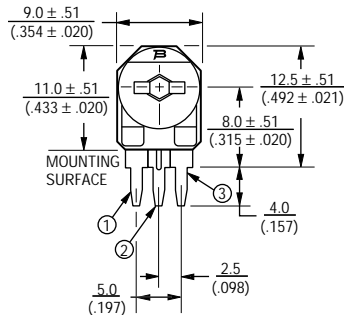

3319W-2 Both Sides Adjust /Cross Slot

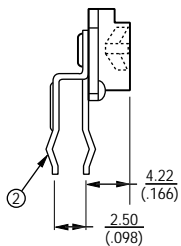
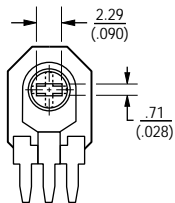

SUGGESTED PWB LAYOUT - 3319W

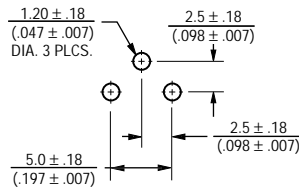

TOLERANCES: ± 0.25 (.010) EXCEPT WHERE NOTED

DIMENSIONS ARE: METRIC / (INCHES)

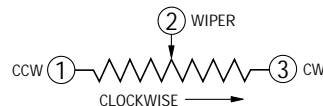

Standard Resistance Table

| Resistance (Ohms) | Resistance Code |
|-------------------|-----------------|
| 100 | 101 |
| 200 | 201 |
| 500 | 501 |
| 1,000 | 102 |
| 2,000 | 202 |
| 5,000 | 502 |
| 10,000 | 103 |
| 20,000 | 203 |
| 50,000 | 503 |
| 100,000 | 104 |
| 200,000 | 204 |
| 500,000 | 504 |
| 1,000,000 | 105 |

Popular values listed in boldface. Special resistances available.

SHADED AREAS TYPICALLY NOT STOCKED BY DISTRIBUTORS AND NOT RECOMMENDED FOR NEW DESIGNS.

AVAILABLE THROUGH DISTRIBUTION

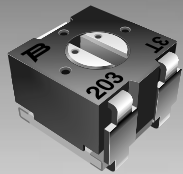

BOURNS®

Features

- Surface Mount / Single-Turn / Cermet Industrial / Sealed
- Compatible with surface mount manufacturing processes
- Standoffs facilitate boardwashing and mechanical stability

- Plastic housing for RF applications
- Low profile
- Patent #5043695 assembly for seal integrity

3324 - 4mm Square Trimming Potentiometer

Electrical Characteristics

Standard Resistance Range10 ohms to 2 megohms (see standard resistance table)
 Resistance Tolerance±20% std. (tighter tolerance available)
 End Resistance1% or 3 ohms max. (whichever is greater)
 Contact Resistance Variation3% or 3 ohms max. (whichever is greater)
 Resolution.....Essentially Infinite
 Insulation Resistance500 vdc. 100 megohms min.
 Dielectric Strength
 Sea Level.....500 vac (1 minute)
 Adjustment Angle220° nom.

Environmental Characteristics

Soldering Heat260°C, 10 seconds, TRS ±1%
 Power Rating (200 volts max.)
 70°C.....0.25 watt
 125°C.....0 watt
 Operating Temperature Range-55°C to +125°C
 Temperature Coefficient
 <100 Ohms±150ppm/°C
 >100 Ohms±100ppm/°C
 Humidity80-98% RH, 10 cycles, 240 hours TRS ±3%; IR 10 megohms
 Vibration20G TRS ±1%; VRS ±1%
 Shock100G TRS ±1%; VRS ±1%
 Load Life(@ 70°C Rated Power 1000 Hours) TRS ±3%
 Rotational Cycling.....100 cycles TRS ±3%
 Thermal Shock.....5 cycles TRS ±2%; VRS ±1%

Physical Characteristics

Mechanical Angle250° nom.
 Torque50g-cm typical
 Stop Strength200g-cm typical
 WeightApproximately 0.01 oz.
 MarkingManufacturer's code, resistance code and date code
 WiperPositioned at 50% nominal
 FlammabilityU.L. 94V-0
 Adjustment ToolH-91

How To Order

Model 3324 J - 1 - 502 E
 Style _____
 Standard or Modified Product Indicator _____
 -1 = Standard Product
 Resistance Code _____
 Embossed Tape _____
 1000 pcs./7" Reel (Standard)

3324J Common Dimensions

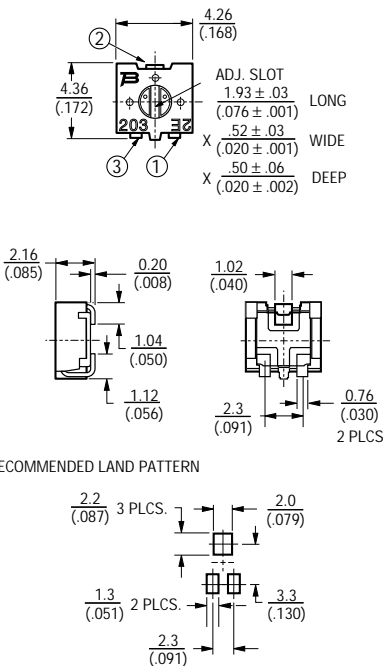

3324G

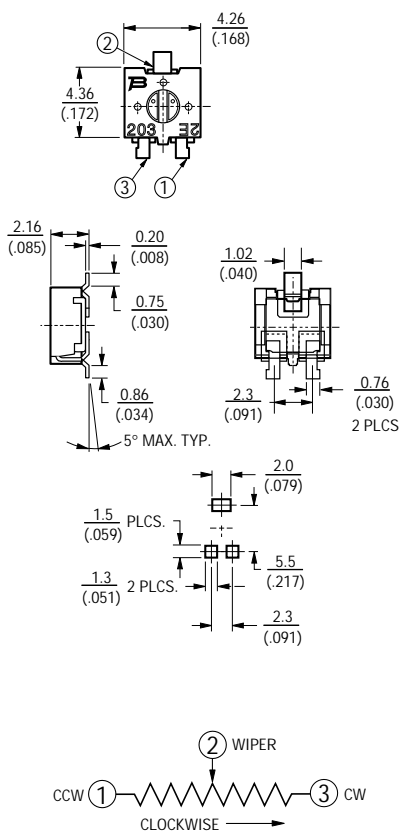

TOLERANCES: ± 0.25 (.010) EXCEPT WHERE NOTED

DIMENSIONS ARE: METRIC / (INCHES)

3324 - 4mm Square Trimming Potentiometer



Packaging Specifications

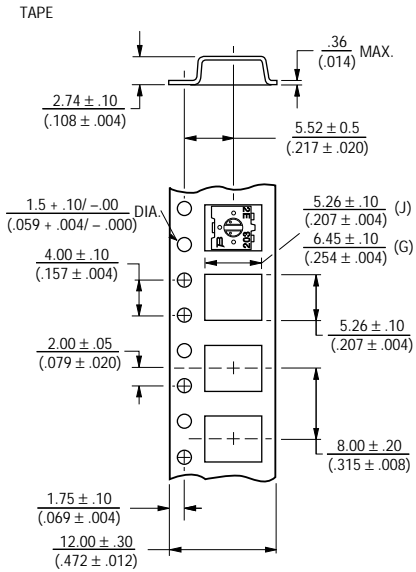

Standard Resistance Table

| Resistance (Ohms) | Part Marking Code | Resistance Code |
|-------------------|-------------------|-----------------|
| 10 | A1 | 100 |
| 20 | 21 | 200 |
| 50 | 51 | 500 |
| 100 | A2 | 101 |
| 200 | 22 | 201 |
| 500 | 52 | 501 |
| 1,000 | A3 | 102 |
| 2,000 | 23 | 202 |
| 5,000 | 53 | 502 |
| 10,000 | A4 | 103 |
| 20,000 | 24 | 203 |
| 50,000 | 54 | 503 |
| 100,000 | A5 | 104 |
| 200,000 | 25 | 204 |
| 500,000 | 55 | 504 |
| 1,000,000 | A6 | 105 |
| 2,000,000 | 26 | 205 |

Popular values listed in boldface. Special resistances available.

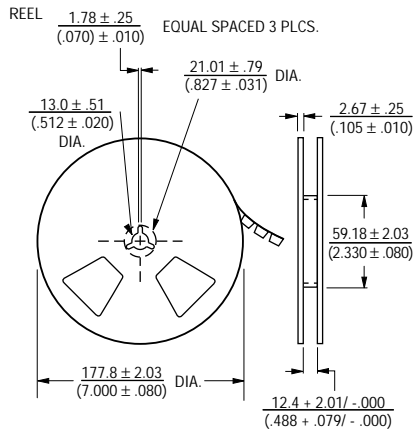

Meets EIA specification 481.

TOLERANCES: ± 0.25 (.010) EXCEPT WHERE NOTED

DIMENSIONS ARE: $\frac{\text{METRIC}}{\text{(INCHES)}}$

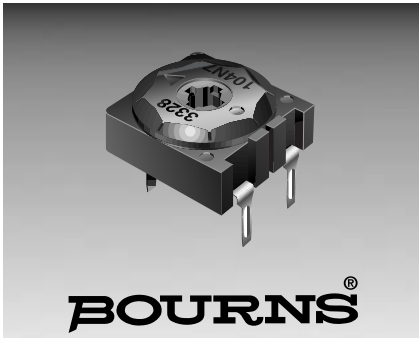

Features

- Single-turn / conductive plastic
- Commercial / dust proof / fully enclosed
- Cross slot rotor design suitable for automatic adjustment equipment
- Hexagon adjustment design
- PC board stand-off and retention feature
- Adjustable front/back, top/bottom

3328 - 9mm Square Trimming Potentiometer

Electrical Characteristics

Resistance Range.....100Ω - 5.0 MΩ
 Resistance Tolerance
 100Ω - 1.0 MΩ, ± 20%
 >1.0MΩ- 5.0 MΩ, ± 30%
 End Resistance3% Max
 Contact Resistance Variation3Ω or 3%
 whichever is greater
 Resolution(Infinite)
 Adjustment Angle220°±20°
 Max. Operating Voltage200 V

Environmental Characteristics

Power Rating.....40°C, 0.20 Watts
 Temperature Range.....-25°C to + 70° C
 Temperature Coefficient of Resistance
 ±400 ppm, 100Ω < TR ≤ 1 MΩ
 Load Life1000 hours 0.20w at 40°C,
 TRS ±10%
 Vibration20 g, TRS ± 2%, VRS ± 2%
 Shock100 g, TRS ± 2%, VRS ± 2%
 Rotational Cycling500 cycles,
 TRS ± 3%

Physical Characteristics

Torque (Operating).....50-200 g.cm
 Stop Strength550 g.cm
 TerminalsSolderable Pins
 Marking.....Manufacturer's trademark,
 resistance code and date code
 Standard Packaging ...200 Pcs. per Bag
 Mechanical Angle250° ± 20°
 Flammability.....UL94V-0
 Wiper Position50% nominal

Product Dimensions

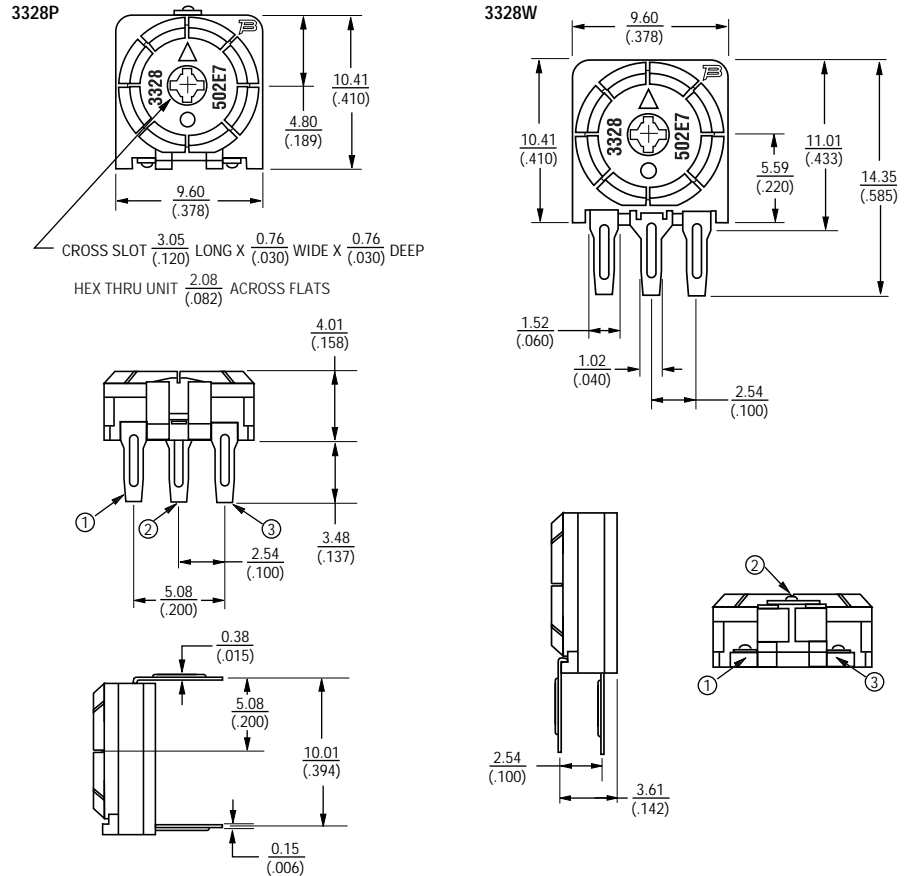

DIMENSIONS ARE: METRIC (INCHES)

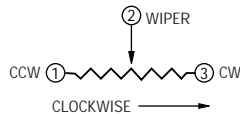

RECOMMENDED PWB MOUNTING PATTERN

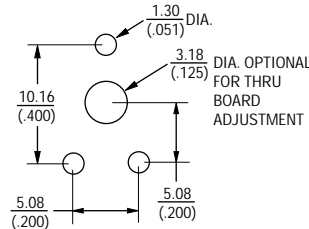

RECOMMENDED PWB MOUNTING PATTERN

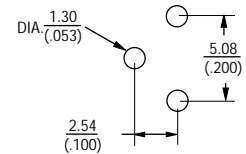

ADJUSTMENT ACCESSORIES

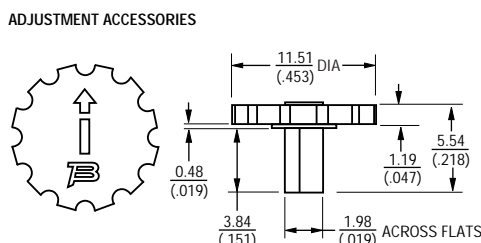

H118-1 Wheel

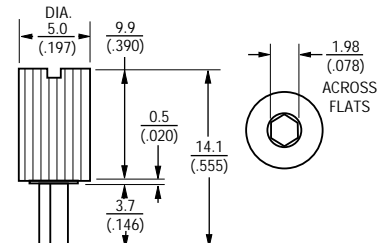

H118-2 Shaft

3328 - 9mm Square Trimming Potentiometer



How to Order

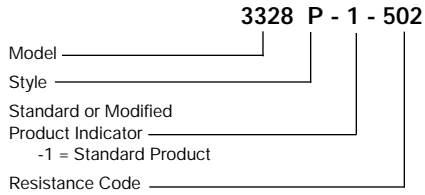

Adjustment accessories as noted.
 Example: H118-1 = Wheel

Standard Resistance Table

| Resistance (Ohms) | Resistance Code | Resistance (Ohms) | Resistance Code |
|-------------------|-----------------|-------------------|-----------------|
| 100 | 101 | 50000 | 503 |
| 500 | 501 | 100000 | 104 |
| 1000 | 102 | 200000 | 204 |
| 2000 | 202 | 500000 | 504 |
| 5000 | 502 | 1000000 | 105 |
| 10000 | 103 | 2000000 | 205 |
| 20000 | 203 | 5000000 | 505 |
| 25000 | 253 | | |

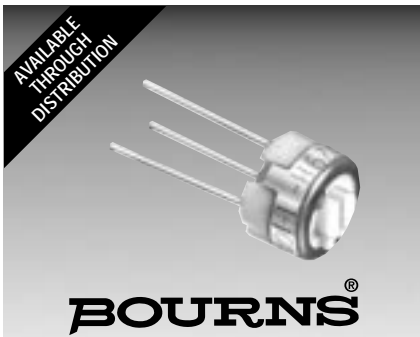

Features

- 1/4" Round / Single-Turn / Cermet Industrial / Sealed
- 5 standard terminal styles
- Tape and reel packaging available (see page 71 for details)

3329 - 1/4" Round Trimming Potentiometer

Electrical Characteristics

Standard Resistance Range10 to 1 megohm
 (see standard resistance table)
 Resistance Tolerance±10% std.
 (closer tolerance available)
 Absolute Minimum Resistance1% or 2 ohms
 (whichever is greater)
 Contact Resistance Variation3.0% or 3 ohms max.
 (whichever is greater)
 Adjustability
 Voltage±0.05%
 Resistance±0.15%
 Resolution.....Infinite
 Insulation Resistance500 vdc.
 1,000 megohms min.
 Dielectric Strength
 Sea Level600 vac
 80,000 Feet250 vac
 Adjustment Angle240° nom.

Environmental Characteristics

Power Rating @ 85°C (300 volts max.)0.5 watt
 Power Rating @ 150°C0 watt
 Temperature Range-55°C to +150°C
 Temperature Coefficient±100ppm/°C
 Seal Test85°C Fluorinert*
 Humidity.....MIL-STD-202 Method 106
 96 hours
 (3% ΔTR, 10 Megohms IR)
 Vibration.....30G (1% ΔTR; 1% ΔVR)
 Shock.....100G (1% ΔTR; 1% ΔVR)
 Load Life
1,000 hours 0.5 watt @ 85°C
 (3% ΔTR; 3% CRV)
 Rotational Life.....200 cycles
 (4% ΔTR; 4% CRV)

Physical Characteristics

Mechanical Angle260° nom.
 Torque5.0 oz-in. max.
 Stop Strength5.0 oz-in. min.
 TerminalsSolderable pins
 Weight0.02 oz.
 MarkingManufacturer's trademark,
 resistance code, date code,
 manufacturer's model number
 and style
 WiperPositioned at 50% nominal
 Standard Packaging50 pcs. per tube
 Adjustment ToolH-90

3329H

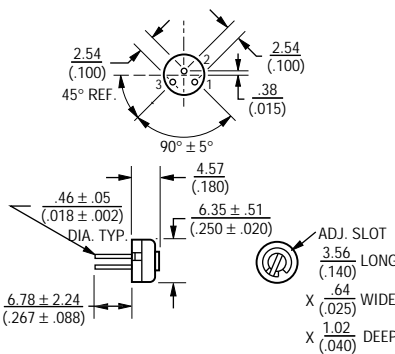

3329P

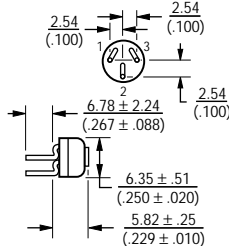

3329S

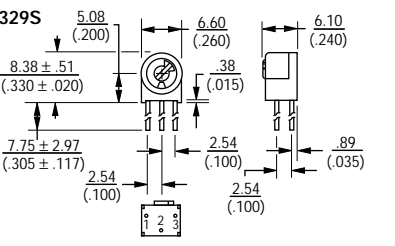

3329W

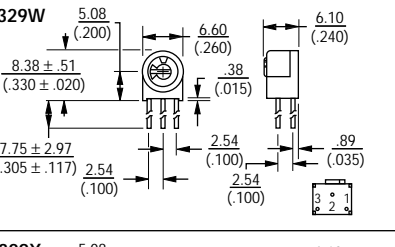

3329X

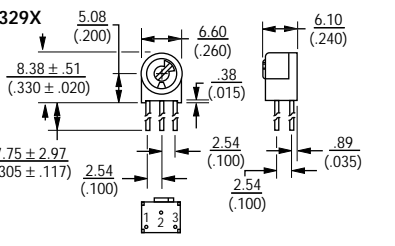

TOLERANCES: ± 0.25 (.010) EXCEPT WHERE NOTED

DIMENSIONS ARE: METRIC / (INCHES)

3329P-DK9-RC

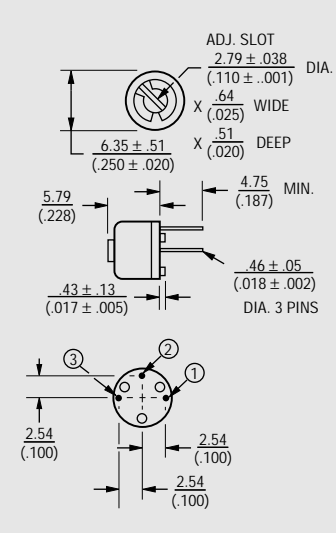

How To Order

Model **3329 H - 1 - 103**
 Style _____
 Standard or Modified Product Indicator
 -1 = Standard Product
 -DK9 = Plastic Spacer
 Resistance Code _____
 Consult factory for other available options.

Standard Resistance Table

| Resistance (Ohms) | Resistance Code |
|-------------------|-----------------|
| 10 | 100 |
| 20 | 200 |
| 50 | 500 |
| 100 | 101 |
| 200 | 201 |
| 500 | 501 |
| 1,000 | 102 |
| 2,000 | 202 |
| 5,000 | 502 |
| 10,000 | 103 |
| 20,000 | 203 |
| 25,000 | 253 |
| 50,000 | 503 |
| 100,000 | 104 |
| 200,000 | 204 |
| 250,000 | 254 |
| 500,000 | 504 |
| 1,000,000 | 105 |

Popular values listed in boldface. Special resistances available.
 SHADED AREAS TYPICALLY NOT STOCKED BY DISTRIBUTORS AND NOT RECOMMENDED FOR NEW DESIGNS.

**FLUORINERT* IS A REGISTERED TRADEMARK OF 3M CO.

Specifications are subject to change without notice.

AVAILABLE THROUGH DISTRIBUTION

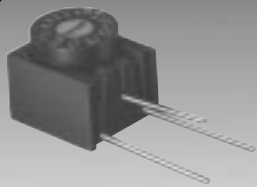

BOURNS®

Features

- Four-Turn / Cermet / Industrial / Sealed
- Unique planetary drive offers precise wiper setting of a multiturn in a single-turn package size
- Top and side adjust styles

3339 - 5/16" Round Trimming Potentiometer

Electrical Characteristics

Standard Resistance Range 10 to 1 megohm
 (see standard resistance table)
 Resistance Tolerance ±10% std.
 (tighter tolerance available)
 Absolute Minimum Resistance 1% or 2 ohms max.
 (whichever is greater)
 Contact Resistance Variation 3% or 3 ohms max.
 (whichever is greater)
 Adjustability
 Voltage ±0.05%
 Resistance ±0.1%
 Resolution Infinite
 Insulation Resistance 500 vdc.
 1,000 megohms min.
 Dielectric Strength
 Sea Level 600 vac
 80,000 Feet 250 vac
 Effective Travel 4 turns nom.

Environmental Characteristics

Power Rating (300 volts max.)
 85°C 0.5 watt
 150°C 0 watt
 Temperature Range -55°C to +150°C
 Temperature Coefficient ±100ppm/°C
 Seal Test 85°C Fluorinert*
 Humidity MIL-STD-202 Method 103
 96 hours
 (3% ΔTR, 10 Megohms IR)
 Vibration 30G (1% ΔTR; 1% ΔVR)
 Shock 100G (1% ΔTR; 1% ΔVR)
 Load Life 1,000 hours 0.5 watt @ 85°C
 (3% ΔTR; 3% or 3 ohms, whichever is greater, CRV)
 Rotational Life 200 cycles
 (3% ΔTR; 3% or 3 ohms, whichever is greater, CRV)

Physical Characteristics

Torque 3 oz-in. max.
 Mechanical Stops Wiper idles
 Terminals Solderable pins
 Weight 0.02 oz.
 Marking Manufacturer's trademark, resistance code, wiring diagram, date code, manufacturer's model number and style
 Wiper Positioned at 50% nominal
 Flammability U.L. 94V-0
 Standard Packaging 50 pcs. per tube
 Adjustment Tool H-90

FLUORINERT IS A REGISTERED TRADEMARK OF 3M CO.

3339H Common Dimensions (Top Adjust)

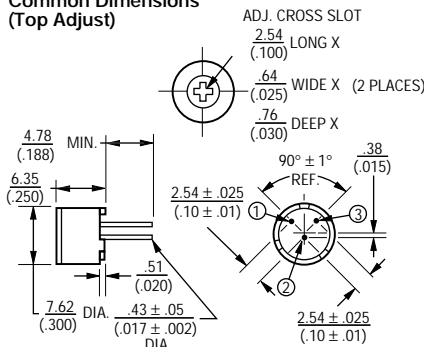

3339P

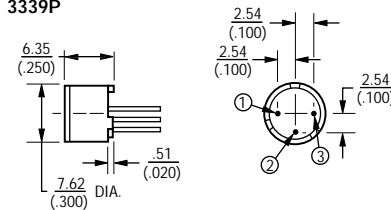

3339S Common Dimensions (Side Adjust)

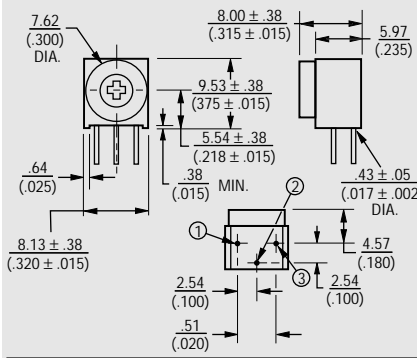

3339W

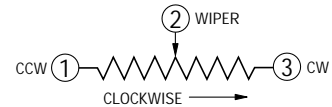
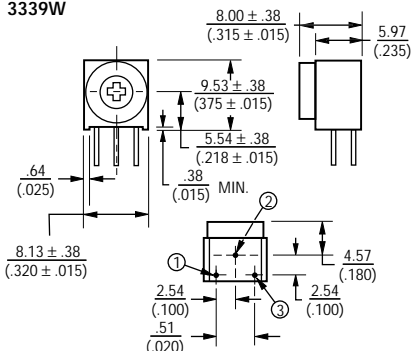

TOLERANCES: ± 0.25 (.010) EXCEPT WHERE NOTED

DIMENSIONS ARE: METRIC (INCHES)

How To Order

3339 H - 1 - 103

Model _____
 Style _____
 Standard or Modified Product Indicator _____
 -1 = Standard Product
 Resistance Code _____
 Consult factory for other available options.

Standard Resistance Table

| Resistance (Ohms) | Resistance Code |
|-------------------|-----------------|
| 10 | 100 |
| 20 | 200 |
| 50 | 500 |
| 100 | 101 |
| 200 | 201 |
| 500 | 501 |
| 1,000 | 102 |
| 2,000 | 202 |
| 5,000 | 502 |
| 10,000 | 103 |
| 20,000 | 203 |
| 25,000 | 253 |
| 50,000 | 503 |
| 100,000 | 104 |
| 200,000 | 204 |
| 250,000 | 254 |
| 500,000 | 504 |
| 1,000,000 | 105 |

Popular values listed in boldface. Special resistances available.

SHADED AREAS TYPICALLY NOT STOCKED BY DISTRIBUTORS AND NOT RECOMMENDED FOR NEW DESIGNS.

AVAILABLE THROUGH DISTRIBUTION

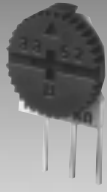

BOURNS®

Features

- Single-Turn / Cermet / Industrial / Open Frame
- Stable cermet element offers infinite resolution
- Very low profile
- Seven standard pin styles

- Thumb and screwdriver adjustment

3352 - 3/8" Round Trimming Potentiometer

Electrical Characteristics

Standard Resistance Range
10 to 2 megohms
 (see standard resistance table)
 Resistance Tolerance±20% std.
 (tighter tolerance available)
 Absolute Minimum Resistance
2 ohms max.
 Contact Resistance Variation
1.0% or 1 ohm max.
 (whichever is greater)
 Adjustability
 Voltage±0.05%
 Resistance±0.25%
 ResolutionInfinite
 Dielectric Strength
 Sea Level500 vac
 80,000 Feet350 vac
 Adjustment Angle205° nom.

Environmental Characteristics

Power Rating (250 volts max.)
 85°C0.50 watt
 125°C0 watt
 Temperature Range
-55°C to +125°C
 Temperature Coefficient
 ±100ppm/°C2K & up
 ±150ppm/°CBelow 2K
 HumidityMIL-STD-202 Method 103
 96 hours
 (2% ΔTR, 10 Megohms IR)
 Vibration30G (2% ΔTR; 2% ΔVR)
 Shock100G (2% ΔTR; 2% ΔVR)
 Load Life
1,000 hours 0.5 watt @ 85°C
 (3% ΔTR)
 Rotational Life200 cycles
 (10% ΔTR)

Physical Characteristics

Mechanical Angle250° nom.
 Torque3.0 oz-in. max.
 Stop Strength8 oz -in. min.
 TerminalsSolderable pins
 Weight0.01 oz.
 MarkingManufacturer's
 trademark, resistance value
 and model number.
 Date code on packaging.
 WiperSet at CW end
 Standard Packaging
100 pcs. per bag
 Adjustment ToolH-90

3352

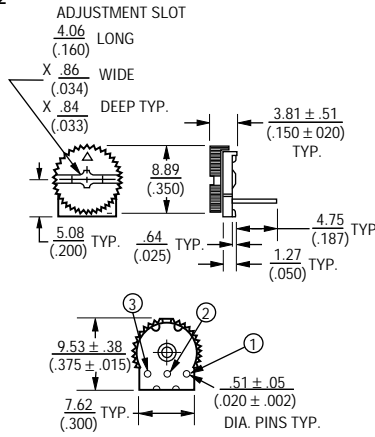

3352E Top Adjust

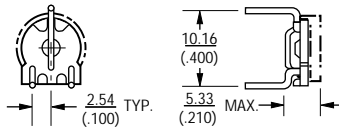

3352P

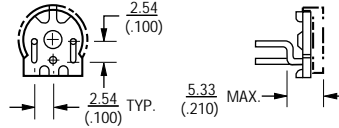

3352T

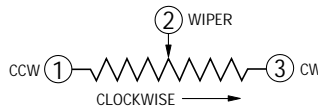
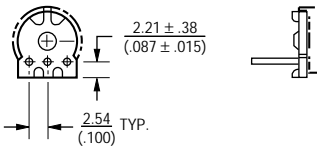

TOLERANCES: ± 0.25 (.010) EXCEPT WHERE NOTED

DIMENSIONS ARE: METRIC (INCHES)

How To Order

3352 W - 1 - 103
 Model _____
 Style _____
 Standard or Modified _____
 Product Indicator _____
 -1 = Standard Product
 Resistance Code _____

Consult factory for other available options.

3352H

Side Adjust

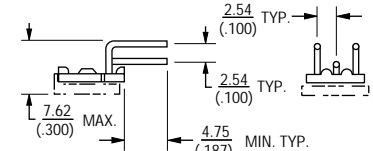

3352K

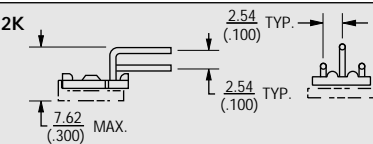

3352V

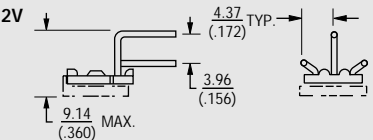

3352W

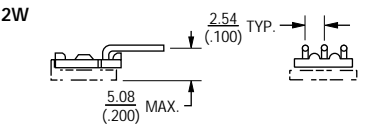

Standard Resistance Table

| Resistance (Ohms) | Resistance Code |
|-------------------|-----------------|
| 10 | 100 |
| 20 | 200 |
| 50 | 500 |
| 100 | 101 |
| 200 | 201 |
| 500 | 501 |
| 1,000 | 102 |
| 2,000 | 202 |
| 5,000 | 502 |
| 10,000 | 103 |
| 20,000 | 203 |
| 25,000 | 253 |
| 50,000 | 503 |
| 100,000 | 104 |
| 200,000 | 204 |
| 250,000 | 254 |
| 500,000 | 504 |
| 1,000,000 | 105 |
| 2,000,000 | 205 |

Popular values listed in boldface. Special resistances available.

SHADED AREAS TYPICALLY NOT STOCKED BY DISTRIBUTORS AND NOT RECOMMENDED FOR NEW DESIGNS.

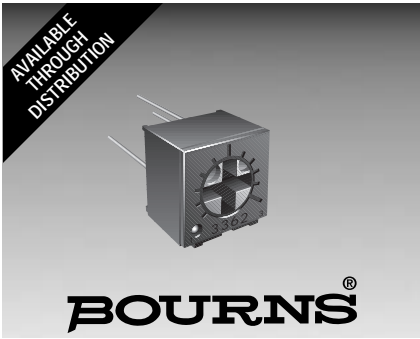

Features

- Single-Turn / Cermet / Industrial / Sealed
- Miniature package
- Rotor designed for automatic machine adjust interface
- Withstands harsh environments and immersion cleaning processes

■ Available on tape and reel packaging (see page 71)

3362 - 1/4" Square Trimming Potentiometer

Electrical Characteristics

Standard Resistance Range 10 to 2 megohms
 (see standard resistance table)
 Resistance Tolerance ±10% std.
 (tighter tolerance available)
 Absolute Minimum Resistance 1% or 2 ohms
 (whichever is greater)
 Contact Resistance Variation 1% or 3 ohms max.
 (whichever is greater)
 Adjustability
 Voltage ±0.05%
 Resistance ±0.15%
 Resolution Infinite
 Insulation Resistance 500 vdc.
 1,000 megohms min.

Dielectric Strength

Sea Level 900 vac
 80,000 Feet 350 vac
 Adjustment Angle 240° nom.

Environmental Characteristics

Power Rating (300 volts max.)
 70°C 0.50 watt
 125°C 0 watt
 Temperature Range -55°C to +125°C
 Temperature Coefficient ±100ppm/°C
 Seal Test 85°C Fluorinert*
 Humidity MIL-STD-202 Method 103
 96 hours
 (2% ΔTR; 10 Megohms IR)
 Vibration 30G (1% ΔTR; 1% ΔVR)
 Shock 100G (1% ΔTR; 1% ΔVR)
 Load Life 1,000 hours 0.5 watt @ 70°C
 (3% ΔTR; 3% or 3 ohms, whichever is greater, CRV)
 Rotational Life 200 cycles
 (4% ΔTR; 3% or 3 ohms, whichever is greater, CRV)

Physical Characteristics

Mechanical Angle 270° nom.
 Torque 3.0 oz-in. max.
 Stop Strength 7.0 oz-in. min.
 Terminals Solderable pins
 Weight 0.02 oz.
 Marking Resistance code, terminal numbers, manufacturer's model number, style and date code
 Wiper Positioned at 50% nominal
 Flammability U.L. 94V-0
 Standard Packaging 50 pcs. per tube
 Adjustment Tool H-90

FLUORINERT IS A REGISTERED TRADEMARK OF 3M CO.

Common Dimensions Top Adjust

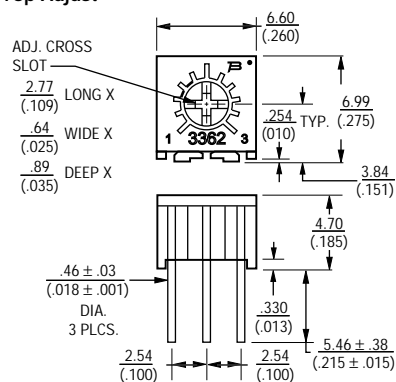

3362H

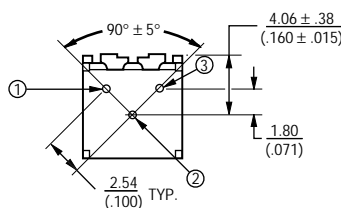

3362P

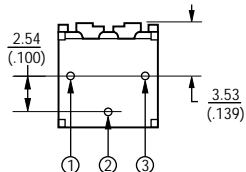

3362R

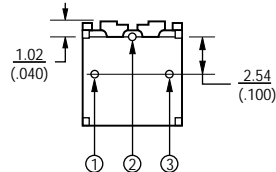

3362U

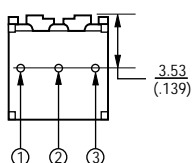

Common Dimensions Side Adjust

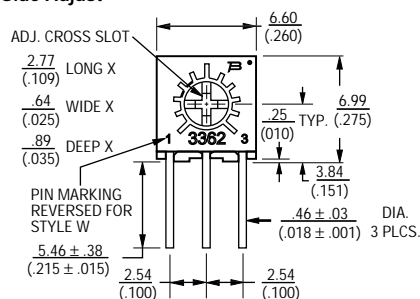

3362M

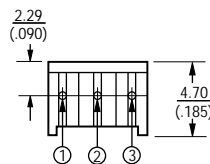

3362S

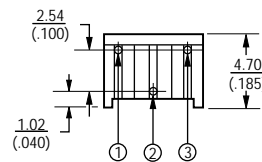

3362W

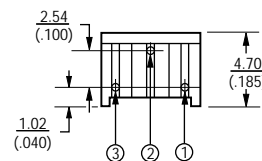

3362X

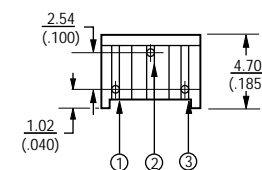

TOLERANCES: ± 0.25 (.010) EXCEPT WHERE NOTED

DIMENSIONS ARE: METRIC (INCHES)

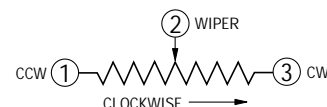

Specifications are subject to change without notice.

3362 - 1/4" Square Trimming Potentiometer



How to Order

3362 P - 1 - 502

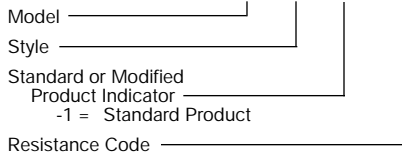

Consult factory for other available options.

Standard Resistance Table

| Resistance (Ohms) | Resistance Code |
|-------------------|-----------------|
| 10 | 100 |
| 20 | 200 |
| 50 | 500 |
| 100 | 101 |
| 200 | 201 |
| 500 | 501 |
| 1,000 | 102 |
| 2,000 | 202 |
| 5,000 | 502 |
| 10,000 | 103 |
| 20,000 | 203 |
| 25,000 | 253 |
| 50,000 | 503 |
| 100,000 | 104 |
| 200,000 | 204 |
| 250,000 | 254 |
| 500,000 | 504 |
| 1,000,000 | 105 |
| 2,000,000 | 205 |

Popular values listed in boldface. Special resistances available.

SHADED AREAS TYPICALLY NOT STOCKED BY DISTRIBUTORS AND NOT RECOMMENDED FOR NEW DESIGNS.



Features

- SMD Single-Turn / Cermet / Industrial Open Frame
- Cross slot rotor designs suitable for automatic adjustment equipment
- Supplied in 12mm embossed tape, compatible with automatic pick-and-place assembly equipment

- Recommended for reflow solder processing only

3364 - 4mm Square Trimming Potentiometer

Electrical Characteristics

Standard Resistance Range
100 ohms to 1 megohm
 (see standard resistance table)
 Resistance Tolerance±25% std.
 End Resistance
 <1K20 ohms max.
 >1K2%
 Contact Resistance Variation
 (Voltage Divider)5% max.
 Resolution.....Infinite
 Adjustment Angle.....260°±20°

Environmental Characteristics

Power Rating (50 volts max.)
 70°C0.2 watt
 Temperature Range
-40°C to +125°C
 Temperature Coefficient
±250ppm/°C
 Humidity.....500 hours (5% ΔTR)
 Load Life500 hours
 0.2 watt @ 70°C (5% ΔTR)
 Rotational Life20 cycles (15% ΔTR)

Physical Characteristics

Torque.....20 to 200g-cm
 Mechanical AngleContinuous
 Marking.....Resistance code,
 manufacturer's full part number
 and date code on packaging
 Terminals.....Solder coated
 Standard Packaging
1000 pcs./7" reel
 Adjustment ToolH-90
 Reflow solder processing recommended

How To Order

3364 X - 1 - 103 E

Model _____
 Style _____
 Orientation of parts in tape:
 Styles W,A
 Terminals toward sprocket holes
 Styles X,B
 Terminals away from sprocket holes
 Standard Product _____
 Resistance Code _____
 Embossed Tape Designator
 E = 1000 pcs./7" reel (-1 standard)
 G = 5000 pcs./14.5" reel (-1 optional)
 Consult factory for other available options.

Common Dimensions 3364W, X 3-Terminal

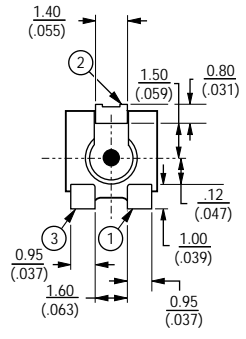
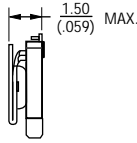
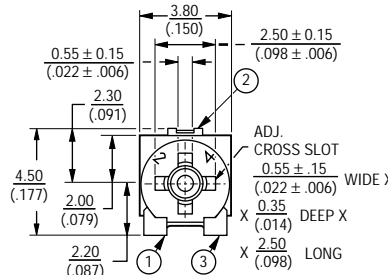

SUGGESTED PWB LAYOUT

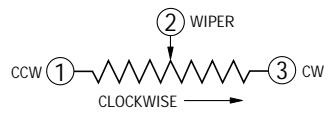
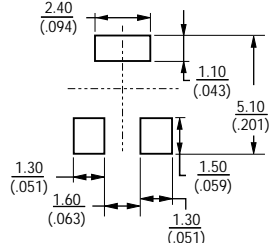

TOLERANCES: ± 0.25 (.010) EXCEPT WHERE NOTED
 DIMENSIONS ARE: $\frac{\text{METRIC}}{\text{(INCHES)}}$

3364A, B 3-Terminal

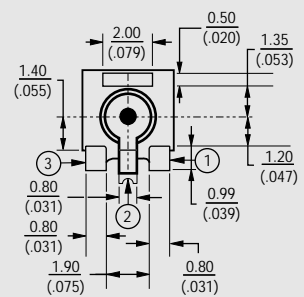
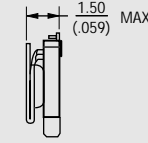
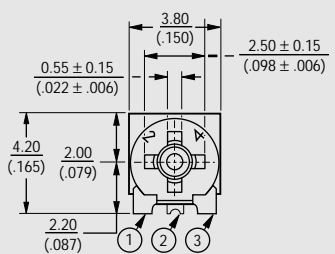

SUGGESTED PWB LAYOUT

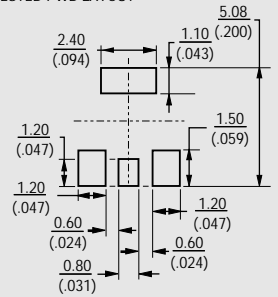

SHADED AREAS TYPICALLY NOT STOCKED BY DISTRIBUTORS AND NOT RECOMMENDED FOR NEW DESIGNS.

3364 - 4mm Square Trimming Potentiometer



Packaging Specifications

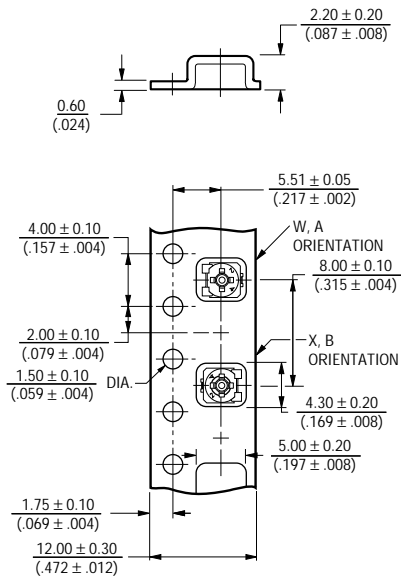

TAPE

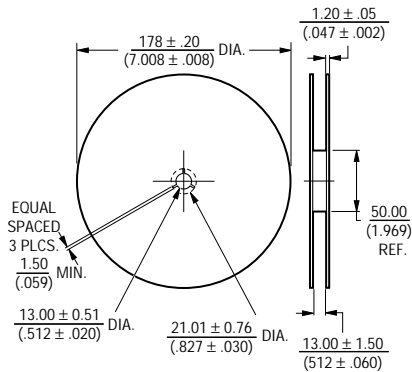

REEL

Conforms with EIA specification RS-481.

Standard Resistance Table

| Resistance (Ohms) | Resistance Code | Part Marking |
|-------------------|-----------------|--------------|
| 100 | 101 | 12 |
| 200 | 201 | 22 |
| 500 | 501 | 52 |
| 1,000 | 102 | 13 |
| 2,000 | 202 | 23 |
| 5,000 | 502 | 53 |
| 10,000 | 103 | 14 |
| 20,000 | 203 | 24 |
| 50,000 | 503 | 54 |
| 100,000 | 104 | 15 |
| 200,000 | 204 | 25 |
| 500,000 | 504 | 55 |
| 1,000,000 | 105 | 16 |

Popular values listed in boldface. Special resistances available.



Features

- Surface Mount / Single-Turn Cermet / Process Sealed
- Elastomer seal allows multiple adjustments (5 rotations)
- Compatible with all surface mount manufacturing processes
- Recommended for reflow processing only
- Cross-slot rotor design suitable for automatic adjustment equipment
- Supplied in 12mm embossed tape, compatible with automatic pick-and-place assembly equipment
- Patent #5,095,298
- Plastic rotor minimizes RF & ESD concerns

3374 - 4mm Square Trimming Potentiometer

Electrical Characteristics

Standard Resistance Range 10 to 2 megohms
 (see standard resistance table)
 Resistance Tolerance ±20% std.
 End Resistance 1% or 2 ohms max.
 (whichever is greater)
 Contact Resistance Variation 3% or 3 ohms max.
 (whichever is greater)
 Resolution Infinite
 Adjustment Angle 240° nom.
 Maximum Voltage 200V

Environmental Characteristics

Power Rating
 70°C 0.25 watt
 125°C 0 watt
 Operating Temperature Range -55°C to +125°C
 Temperature Coefficient
 <500K ohms ±100ppm/°C
 ≥500K ohms ±150ppm/°C
 Seal 5 turns min.
 Humidity MIL-STD 202 Method 103
 Vibration 20G; TRS ±1%, VRS ±1%
 Shock 100G; TRS ±1%, VRS ±1%
 Load Life (@70°C Rated Power, 1000 hours) TRS ±3%
 Rotational Life 100 cycles; TRS ±3%
 Thermal Shock 5 cycles
 TRS ±2%, VRS ±1%

Physical Characteristics

Torque 18 - 180gm/cm
 Mechanical Angle Continuous
 Marking Manufacturer's trademark and part marking code
 Wiper Positioned at 50% nominal
 Standard Packaging 750 pcs./7" reel
 Adjustment Tool H-90

How To Order

Model 3374 X - 1 - 502 E
 Style _____
 Orientation of Parts in Tape:
 Style W - Terminals Toward Sprocket Holes
 Standard or Modified Product Indicator
 -1 = Standard Product
 Resistance Code _____
 Embossed Tape
 750 pcs./7" reel (standard)

Consult factory for other available options.

3374X/W

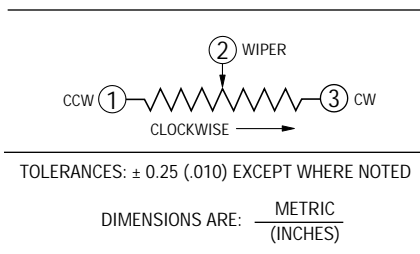
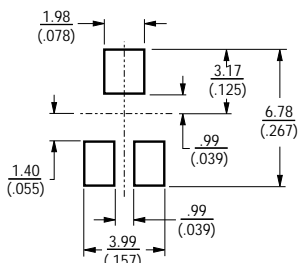
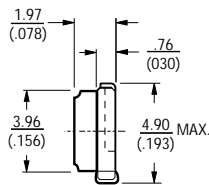
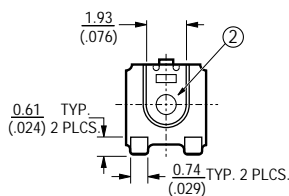
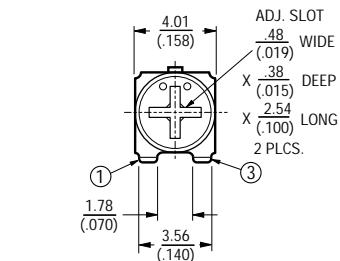

Packaging Specifications

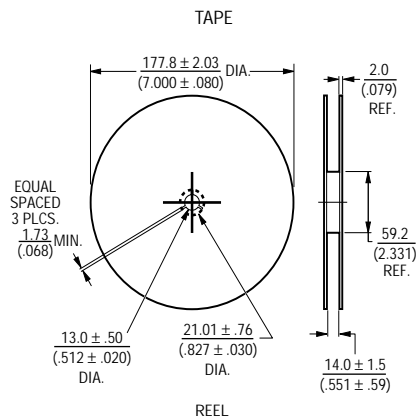
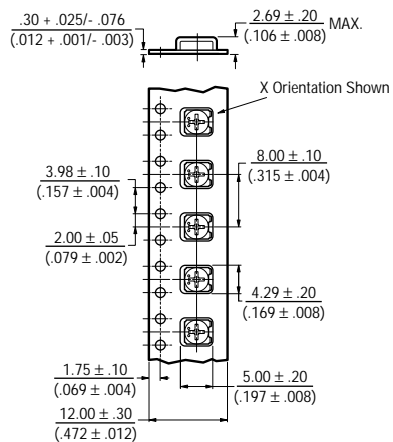

Meets EIA 481

Standard Resistance Table

| Resistance (Ohms) | Part Marking Code | Resistance Code |
|-------------------|-------------------|-----------------|
| 10 | A1 | 100 |
| 20 | 21 | 200 |
| 50 | 51 | 500 |
| 100 | A2 | 101 |
| 200 | 22 | 201 |
| 500 | 52 | 501 |
| 1,000 | A3 | 102 |
| 2,000 | 23 | 202 |
| 5,000 | 53 | 502 |
| 10,000 | A4 | 103 |
| 20,000 | 24 | 203 |
| 50,000 | 54 | 503 |
| 100,000 | A5 | 104 |
| 200,000 | 25 | 204 |
| 500,000 | 55 | 504 |
| 1,000,000 | A6 | 105 |
| 2,000,000 | 26 | 205 |

Popular values listed in boldface. Special resistances available.

SHADED AREAS TYPICALLY NOT STOCKED BY DISTRIBUTORS AND NOT RECOMMENDED FOR NEW DESIGNS.

Specifications are subject to change without notice.

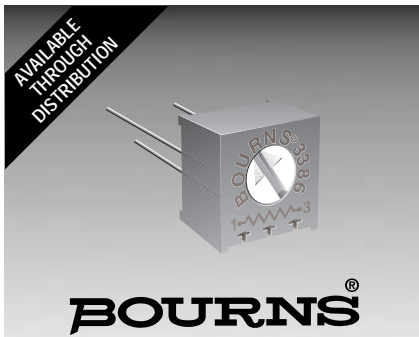

Features

- Single Turn / Cermet / Industrial / Sealed
- Available on tape and reel (see page 71 for details)
- Available with a knob for finger adjust
- Available with extended shaft
- Available with cross-slot rotor

- Top and side adjust types (F, P, H, W, X most popular)
- High voltage types available (see page 61 for details)

3386 - 3/8" Square Trimming Potentiometer

Electrical Characteristics

Standard Resistance Range10 to 2 megohms
 (see standard resistance table)
 Resistance Tolerance±10% std.
 (tighter tolerance available)
 Absolute Minimum Resistance2 ohms max.
 Contact Resistance Variation2% or 3 ohms max.
 (whichever is greater)
 Adjustability
 Voltage±0.05%
 Resistance±0.15%
 Resolution.....Infinite
 Insulation Resistance500 vdc.
 1,000 megohms min.
 Dielectric Strength
 Sea Level900 vac
 70,000 Feet350 vac
 Adjustment Angle280° nom.

Environmental Characteristics

Power Rating (300 volts max.)
 85°C0.5 watt
 125°C0 watt
 Temperature Range-55°C to +125°C
 Temperature Coefficient±100ppm/°C
 Seal Test85°C Fluorinert*
 Humidity.....MIL-STD-202 Method 103
 96 hours
 (2% ΔTR, 10 Megohms min.)
 Vibration.....30G (1% ΔTR; 1% ΔVR)
 Shock.....100G (1% ΔTR; 1% ΔVR)
 Load Life1,000 hours 0.5 watt @ 70°C
 (3% ΔTR; 1% or 1 ohm, whichever is greater, CRV)
 Rotational Life200 cycles
 (4% ΔTR; 1% or 1 ohm, whichever is greater, CRV)

Physical Characteristics

Mechanical Angle310° nom.
 Torque5.0 oz-in. max.
 Stop Strength15.0 oz-in. min.
 TerminalsSolderable pins
 Weight0.03 oz.
 MarkingManufacturer's trademark, resistance code, wiring diagram, date code, manufacturer's model number and style
 Standard Packaging50 pcs. per tube
 Wiper Positioned at 50% Nominal
 Adjustment ToolH-90

**FLUORINERT* IS A REGISTERED TRADEMARK OF 3M CO.

Specifications are subject to change without notice.

Common Dimensions Side Adjust

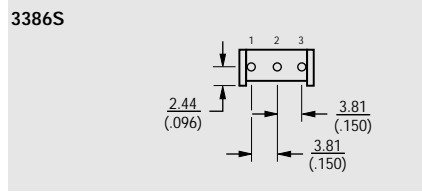
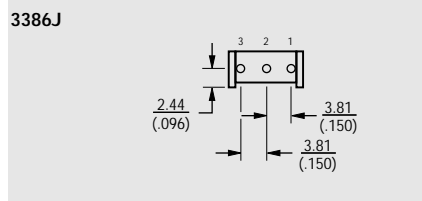
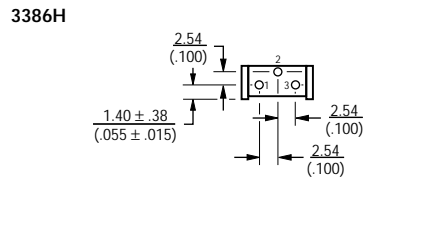
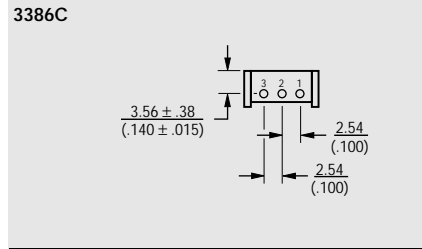
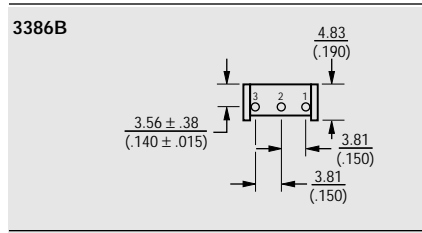
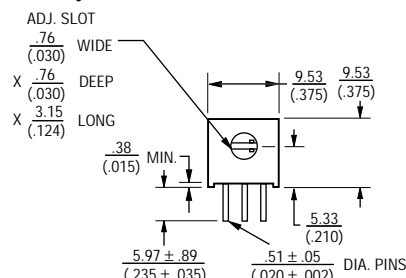

3386W

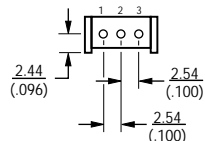

3386X

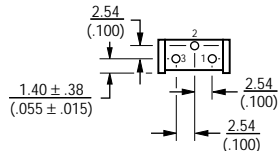

Standard Resistance Table

| Resistance (Ohms) | Resistance Code |
|-------------------|-----------------|
| 10 | 100 |
| 20 | 200 |
| 50 | 500 |
| 100 | 101 |
| 200 | 201 |
| 500 | 501 |
| 1,000 | 102 |
| 2,000 | 202 |
| 5,000 | 502 |
| 10,000 | 103 |
| 20,000 | 203 |
| 25,000 | 253 |
| 50,000 | 503 |
| 100,000 | 104 |
| 200,000 | 204 |
| 250,000 | 254 |
| 500,000 | 504 |
| 1,000,000 | 105 |
| 2,000,000 | 205 |

Special resistances available.

How To Order

3386 P - 1 - 103 T

Model _____
 Style _____
 Standard or Modified Product Indicator _____
 -1 = Standard Product
 -EY5 = Extended Shaft
 Resistance Code _____
 Optional Suffix Letter _____
 T = Knob

Consult factory for other available options.

TOLERANCES: ± 0.25 (.010) EXCEPT WHERE NOTED

DIMENSIONS ARE: $\frac{\text{METRIC}}{\text{(INCHES)}}$

SHADED AREAS TYPICALLY NOT STOCKED BY DISTRIBUTORS AND NOT RECOMMENDED FOR NEW DESIGNS.

3386 - 3/8" Square Trimming Potentiometer

BOURNS®

Common Dimensions Top Adjust

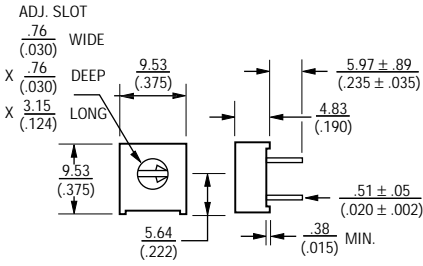

3386F

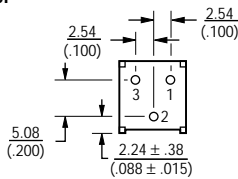

3386K

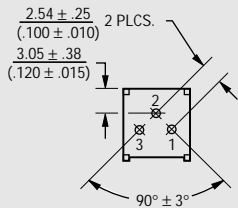

3386M

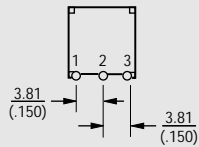

3386P

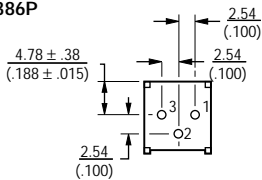

3386R

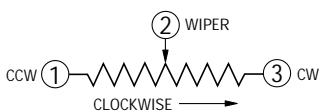
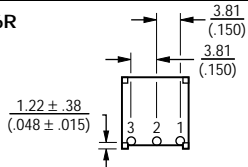

3386T

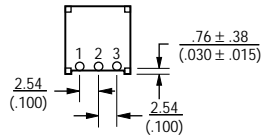

3386U

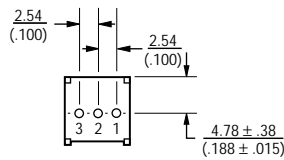

3386Y

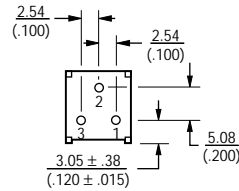

3386G

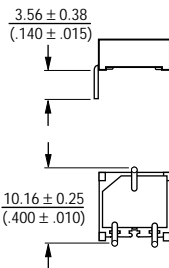
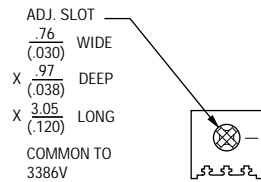

3386V

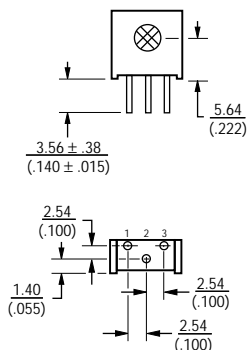

3386H-EY5 3386X-EY5 - SHOWN

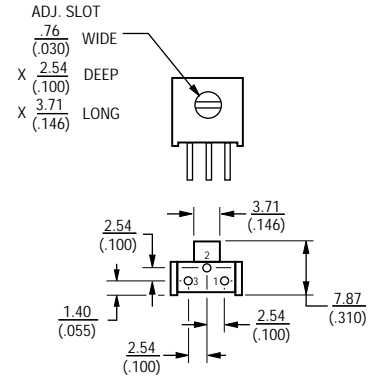

3386P-EY5

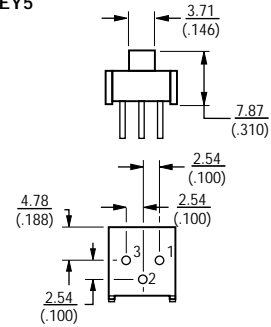

The Model 3386 is available with a knob for finger adjustment. Add suffix letter "T" to order code for F, P and X terminal styles.

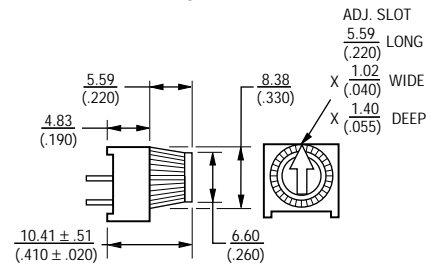

SHADED AREAS TYPICALLY NOT STOCKED BY DISTRIBUTORS AND NOT RECOMMENDED FOR NEW DESIGNS.



BOURNS®

Features

- 3/8" Square / Single-Turn / Cermet Industrial / Sealed High Voltage Focus Control
- Designed for electrostatic focus control applications on monochrome or color CRTs

- Rated at 1KV D.C. and 600 VDC input voltage
- High stability cermet element
- Available with optional red knob

3386 HV2/3386 HV3 - 3/8" Trimming Potentiometer

Electrical Characteristics

Standard Resistance Range2.5 and 5 megohms
 Resistance Tolerance±20%
 Contact Resistance Variation2% max.
 Adjustability
 Voltage Divider±0.05%
 Rheostat±0.15%
 ResolutionInfinite
 Insulation Resistance @ 1KV D.C.1,000 megohms min.
 Dielectric Strength (5,000 foot altitude)1.5 KV A.C. min.
 Adjustment Angle280° nom.

Environmental Characteristics

HV2 Input Voltage
 85°C(1 KVDC max.)
 125°C0 watt
 HV3 Input Voltage
 85°C(600 VDC max.)
 125°C0 watt
 Temperature Range-55°C to +125°C
 Temperature Coefficient±400ppm/°C
 HumidityMIL-STD-202 Method 103
 240 Hours (100 megohms min. IR)
 Load Life
 HV21,000 hours 1 KVDC
 60°C, 90% R.H. (3% max. ΔTR)
 HV31,000 hours 600 VDC
 60°C, 90% R.H. (3% max. ΔTR)
 Voltage Breakdown (5,000 foot altitude)1.5 KV min.
 Seal Test85°C Fluorinert*
 VibrationNo discontinuity 30G
 ShockNo discontinuity 100G
 Rotational Life200 cycles min.

Physical Characteristics

Mechanical Angle310° nom.
 Torque5.0 oz-in. max.
 Stop Strength15.0 oz-in. min.
 TerminalsSolderable pins
 Weight0.04 oz.
 MarkingManufacturer's trademark, resistance code, wiring diagram, date code, manufacturer's model number and style
 FlammabilityU.L. 94V-0
 Standard Packaging50 pcs. per tube
 Adjustment ToolH-90

3386N

Common Dimensions

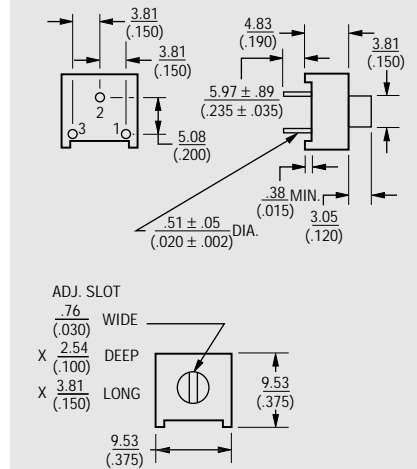

3386U

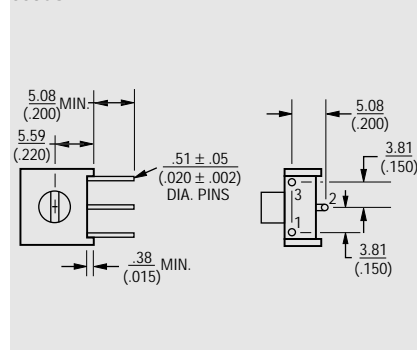

Typical Focus Control Circuits

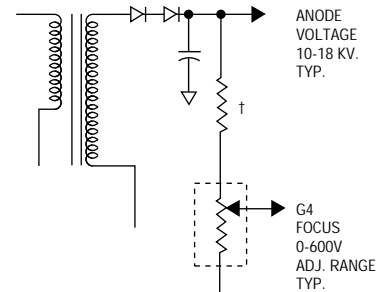

MONOCHROME
 † VALUES DETERMINED BY CIRCUIT VOLTAGES

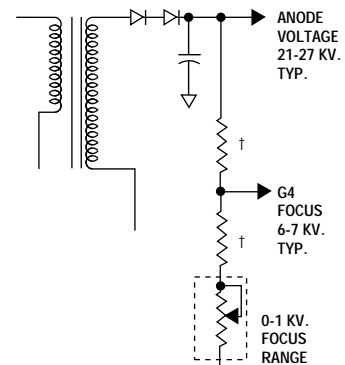

COLOR

How To Order

3386 N - HV2 - 505 T

Model _____
 Style _____
 High Voltage Construction Indicator
 HV2 = 1000 VDC
 HV3 = 600 VDC
 Resistance Code _____
 -255 = 2.5 megohms
 -505 = 5 megohms
 Optional Suffix Letter _____
 T = Red Knob

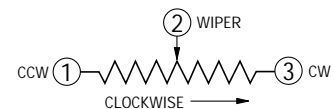

TOLERANCES: ± 0.25 (.010) EXCEPT WHERE NOTED

DIMENSIONS ARE: $\frac{\text{METRIC}}{\text{(INCHES)}}$

SHADED AREAS TYPICALLY NOT STOCKED BY DISTRIBUTORS AND NOT RECOMMENDED FOR NEW DESIGNS.

**"FLUORINERT" IS A REGISTERED TRADEMARK OF 3M CO.

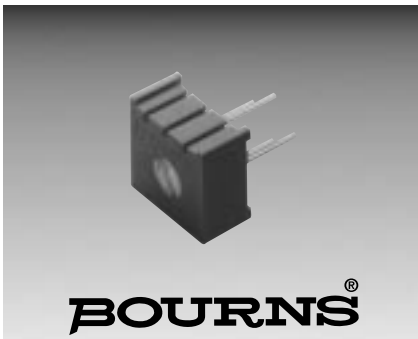

Features

- Single-Turn / Cermet / Industrial / Sealed
- Designed for operational amplifier offset voltage adjustment applications
- Reduces power supply drift errors
- Unique center tapped trimming potentiometer

- Vertical adjust type available

3386-OT1 - 3/8" Square Trimming Potentiometer

Electrical Characteristics

Standard Resistance Range
100 ohms to 1 megohm
 (see standard resistance table)
 Resistance Tolerance±20% std.
 Absolute Minimum Resistance
2 ohms max.
 Voltage Output Variation.....±0.25%
 Adjustability (VR)±0.025%
 Insulation Resistance @ 500 vdc
1,000 megohms min.
 Dielectric Strength
 Sea Level900 vac
 70,000 Feet350 vac
 Effective Electrical Travel.....280° nom.
 Center Tap Resistance2 ohms max.
 Center Tap Electrical Center.....±5%
 Center Tap Dead Band.....6°±4°

Environmental Characteristics

Power Rating
 85°C0.5 watt
 150°C0 watt
 Temperature Range
-55°C to +150°C
 Temperature Stability (ΔVR)
±0.5% max.
 Seal Test85°C Fluorinert*
 Humidity.....MIL-STD-202 Method 103
 96 hours ±2%
 ΔTR 10 Megohms min.
 Vibration, 30G±1% ΔTR
 Shock, 100G±1% ΔTR
 Load Life, 1,000 Hours±3% ΔTR
 Rotational Life, 200 cycles±4% ΔTR

Physical Characteristics

Mechanical Angle310° nom.
 Torque5.0 oz-in. max.
 Stop Strength15.0 oz-in. min.
 TerminalsSolderable pins
 Weight0.03 oz.
 MarkingManufacturer's
 trademark, resistance code,
 wiring diagram, date
 code, manufacturer's model
 number and style
 FlammabilityU.L. 94V-0
 Standard Packaging
50 pcs. per tube/tray
 Adjustment ToolH-90

Also see Model 3296-OT1, page 30.

3386P-OT1

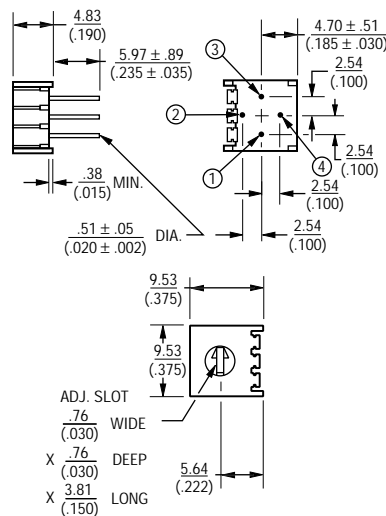

CLOCKWISE →

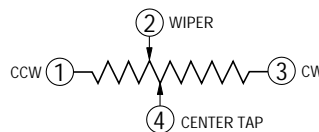

Standard Resistance Table

| Resistance (Ohms) | Resistance Code |
|-------------------|-----------------|
| 100 | 101 |
| 200 | 201 |
| 500 | 501 |
| 1,000 | 102 |
| 2,000 | 202 |
| 5,000 | 502 |
| 10,000 | 103 |
| 20,000 | 203 |
| 50,000 | 503 |
| 100,000 | 104 |
| 200,000 | 204 |
| 500,000 | 504 |
| 1,000,000 | 105 |

Popular values listed in boldface. Special resistances available.

SHADED AREAS TYPICALLY NOT STOCKED BY DISTRIBUTORS AND NOT RECOMMENDED FOR NEW DESIGNS.

TOLERANCES: ± 0.25 (.010) EXCEPT WHERE NOTED

DIMENSIONS ARE: $\frac{\text{METRIC}}{\text{(INCHES)}}$

Suggested Offset Voltage Adjustment Circuit

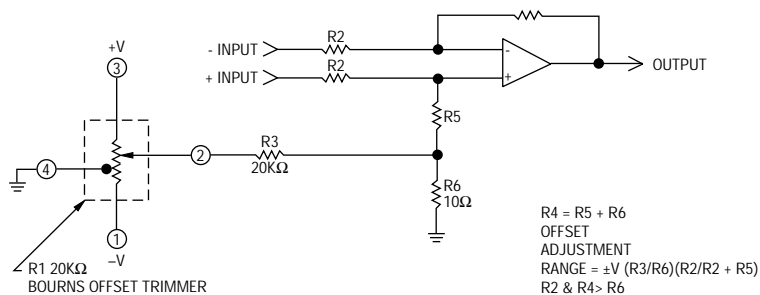

How To Order

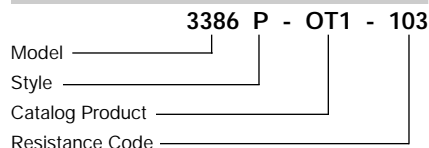

**FLUORINERT* IS A REGISTERED TRADEMARK OF 3M CO.

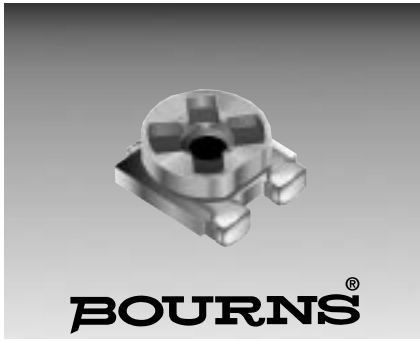

Features

- High temperature plastic rotor
- Recommended for reflow processing
- Rotor design compatible with pick and place and automatic adjustment equipment
- Supplied in 8mm embossed tape, compatible with automatic assembly equipment
- Cermet element

Applications

- Car radios
- Color printers
- Cordless telephones
- CCD Camera control modules
- LCD modules

TC03 - Trimming Potentiometer

Electrical Characteristics

Standard Resistance Range100 to 1 megohm
 (see standard resistance table)
 Resistance Tolerance±25% std.
 Absolute Minimum Resistance
 ≤ 1K Ohms.....20 ohms max.
 >1K Ohms2% max. of TR
 Contact Resistance Variation
5% max.
 Resolution.....Infinite
 Adjustment Angle.....270° ±20°

Environmental Characteristics

Resistance to Soldering Heat
260°C, 10 seconds, TRS max. 5%
 Power Rating (50 VDC max.)
 70°C0.10 watt
 Temperature Range
-40°C to +85°C
 Temperature Coefficient
±250ppm/°C
 Humidity95%RH
 500 hours
 TRS max.±5%
 Load Life
@ 70°C rated power 500 hours
 Rotational Cycling.....20 turns
 TRS ±15%

Physical Characteristics

Torque.....20-200g-cm max.
 Mechanical AngleContinuous
 Marking.....Part marking code
 Standard Packaging
2000 pcs./7" reel

How To Order

TC03 X - 2 - 103 E

Model _____
 Style _____
 Orientation of Parts
 In Tape:
 Style X: Terminals Away
 From Sprocket
 Holes
 Standard or Modified
 Product Indicator _____
 -2 = Cross Slot Rotor (Std. Product)
 Resistance Code _____
 Embossed Tape Designator _____

Consult factory for other available options.

TC03X-2
 3mm Open Frame
 for Reflow Soldering
 3-Terminal

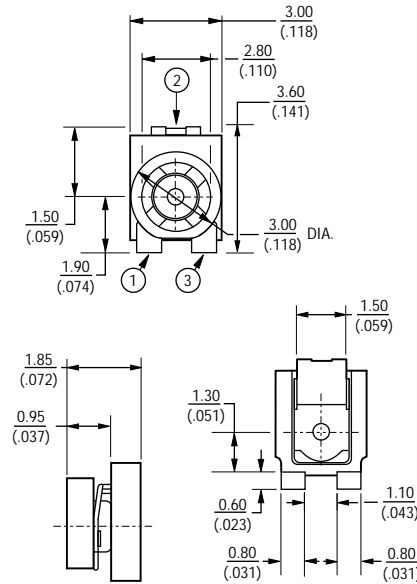

SUGGESTED PWB LAYOUT

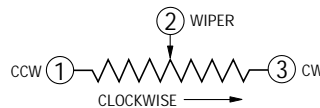
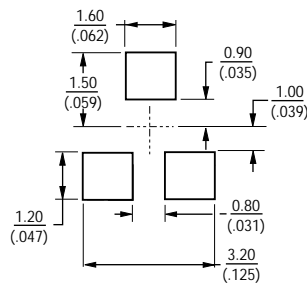

DIMENSIONS ARE: METRIC (INCHES)

Standard Resistance Table

| Resistance (Ohms) | Part Marking Code | Resistance Code |
|-------------------|-------------------|-----------------|
| 100 | 12 | 101 |
| 200 | 22 | 201 |
| 500 | 52 | 501 |
| 1,000 | 13 | 102 |
| 2,000 | 23 | 202 |
| 5,000 | 53 | 502 |
| 10,000 | 14 | 103 |
| 20,000 | 24 | 203 |
| 50,000 | 54 | 503 |
| 100,000 | 15 | 104 |
| 200,000 | 25 | 204 |
| 500,000 | 55 | 504 |
| 1,000,000 | 16 | 105 |

Popular values listed in boldface.



Features

- Recommended for reflow processing
- Rotor design compatible with pick and place and automatic adjustment equipment
- Supplied in 8mm embossed tape, compatible with automatic assembly equipment
- Carbon element

Applications

- Audio car radios
- Satellite receivers - digital/analog
- Computer power supplies

TC73 - Trimming Potentiometer

Electrical Characteristics

Standard Resistance Range500 to 1 megohm
 (see standard resistance table)
 Resistance Tolerance±30% std.
 Absolute Minimum Resistance
 ≤ 1K Ohms20 ohms max.
 >1K Ohms2% max. of TR
 Contact Resistance Variation
5% max.
 ResolutionInfinite
 Adjustment Angle260° ±20°(-2)

Environmental Characteristics

Resistance to Soldering Heat
240°C, 20 seconds, TRS max. 5%
 Power Rating (50 VDC max.)
 50°C0.05 watt
 Temperature Range
-25°C to +85°C
 Temperature Coefficient
±250ppm/°C
 Humidity95%RH
 500 hours
 TRS max.+15% to -2%
 Load Life
@ 50°C rated power 500 hours
 TRS ±5%
 Rotational Cycling20 turns
 TRS ±20%

Physical Characteristics

Torque10-150g-cm max.
 Mechanical Angle
Continuous; 260° ± 20°
 MarkingPart marking code
 Standard Packaging
2000 pcs./7" reel

Soldering Process

Hand SolderingSoldering Iron of 20W
 or less controlled at 280°C for about 3
 sec. while applying solder
 Reflow SolderingPeak temperature
 or reflow oven should be
 set to 240°C max.

Standard Resistance Table

| Resistance (Ohms) | Part Marking Code | Resistance Code |
|-------------------|-------------------|-----------------|
| 500 | 52 | 501 |
| 1,000 | 13 | 102 |
| 2,000 | 23 | 202 |
| 5,000 | 53 | 502 |
| 10,000 | 14 | 103 |
| 20,000 | 24 | 203 |
| 50,000 | 54 | 503 |
| 100,000 | 15 | 104 |
| 200,000 | 25 | 204 |
| 500,000 | 55 | 504 |
| 1,000,000 | 16 | 105 |

Popular values listed in boldface.

TC73X/W-2

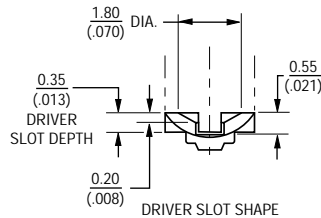
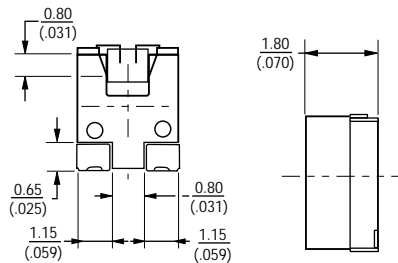
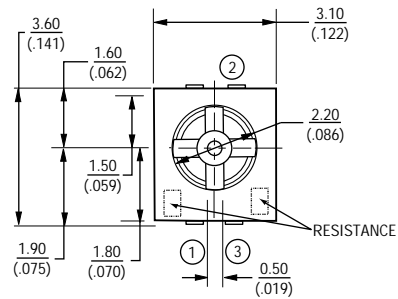

SUGGESTED PCB LAYOUT

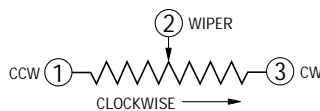
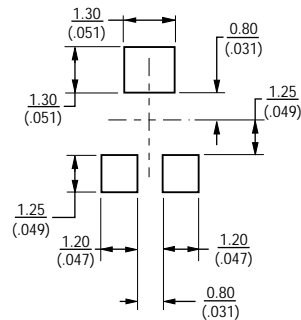

How To Order

TC73 X - 1 - 103 E

Model _____
 Style _____
 Orientation of Parts _____
 In Tape: _____
 Style X: Terminals Away
 From Sprocket
 Holes
 Style W: Terminals in direction
 to sprocket holes
 (preferred)
 Standard or Modified _____
 Product Indicator _____
 1 = Mechanical rotation stop
 (preferred)
 2 = Continuous
 Resistance Code _____
 Embossed Tape Designator _____
 E = 2000 pcs. per reel, 8mm tape

Consult factory for other available options.

DIMENSIONS ARE: METRIC
 (INCHES)

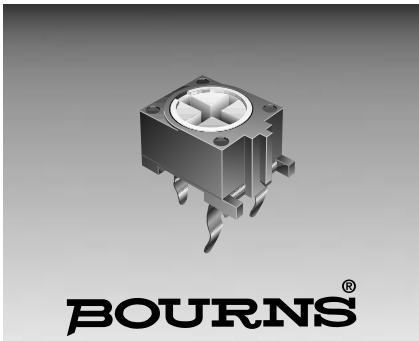

BOURNS®

Features

- Dust-resistant enclosure
- Polyester substrate
- Available on tape and reel for automatic insertion or in bulk for manual assembly
- Adjustable front/back, top/bottom
- Cross slot rotor design suitable for automatic adjustment equipment

Applications

- Power supplies
- Cordless phones
- Printer
- Television sets
- Audio equipment

TC76 - 6mm Carbon Trimming Potentiometer

Electrical Characteristics

| | |
|--|---------------------|
| Taper..... | Linear |
| Standard Resistance Range..... | 100 ohms – 1megohm |
| Resistance Tolerance..... | ±30% |
| Maximum Voltage..... | 100VDC |
| Standard Nominal Resistance Value..... | See table |
| Residual Resistance..... | ≤ 2% (min. 10 ohms) |
| Equivalent Noise Resistance..... | ≤ 5% |

Environmental Characteristics

| | |
|-------------------------------|----------------------------------|
| Power Rating..... | 0.1 Watt @ 40°C |
| Operating Temperature..... | -25°C to 70°C |
| Load Life..... | 1000 hours @ 40°C; 0.1W; ±10% |
| Mechanical Life (Cycles)..... | 100 @ 10CPM; ±3% (Rn < 1M) |
| Temperature Coefficient..... | ±300ppm |
| Thermal Cycling..... | 16 hours @ 85°C; 2h @ -25°C; ±5% |
| Damp Heat..... | 500 hours @ 40°C @ 95% HR; ±5% |
| Vibration..... | 2 hours @ 20g @ 10Hz...50Hz; ±2% |

Physical Characteristics

| | |
|------------------------|--------------|
| Mechanical Angle..... | 280° ±10° |
| Electrical Angle..... | 245° ±25° |
| Rotational Torque..... | 0.2 to 3 Ncm |
| Stop-End Strength..... | >3.5 Ncm |

Packaging Specifications

R: Tape and Reel (W, N, G)

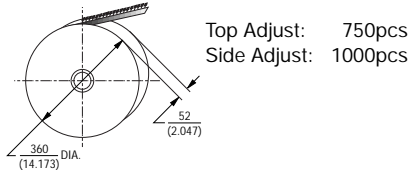

A: Ammo Pack (W, N, G)

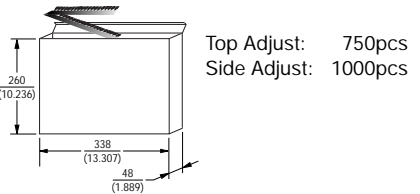

Bulk (B, Z, P)

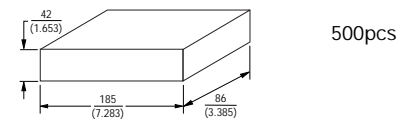

How to Order

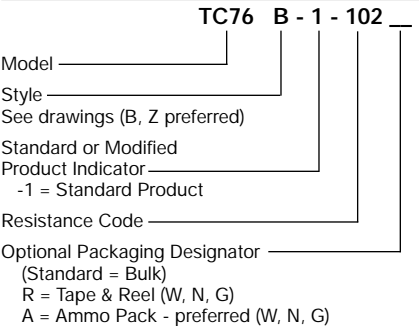

Adjustment Details

Top Adjust Styles G, N, P and Z

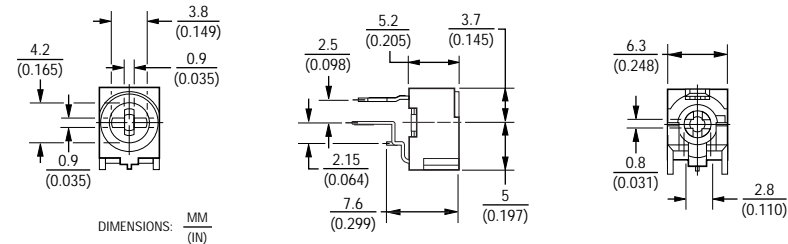

Standard Resistance Table

| Resistance (Ohms) | Resistance Code |
|-------------------|-----------------|
| 100 | 101 |
| 200 | 201 |
| 500 | 501 |
| 1,000 | 102 |
| 2,000 | 202 |
| 5,000 | 502 |
| 10,000 | 103 |
| 20,000 | 203 |
| 50,000 | 503 |
| 100,000 | 104 |
| 200,000 | 204 |
| 500,000 | 504 |
| 1,000,000 | 105 |

SHADED AREAS TYPICALLY NOT STOCKED BY DISTRIBUTORS AND NOT RECOMMENDED FOR NEW DESIGNS.

Side Adjust Styles B and W

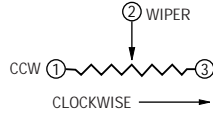
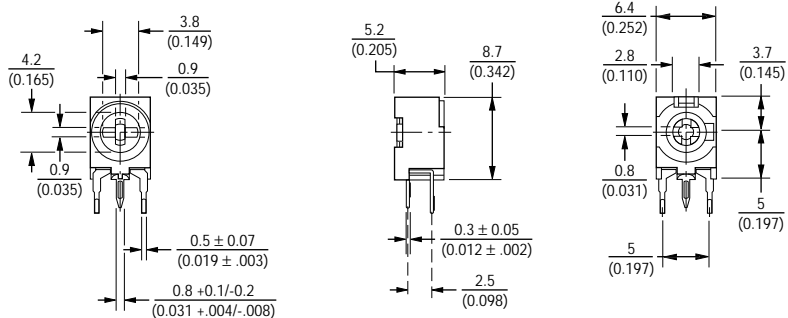

TC76 - 6mm Carbon Trimming Potentiometer

Taped Model TC76W

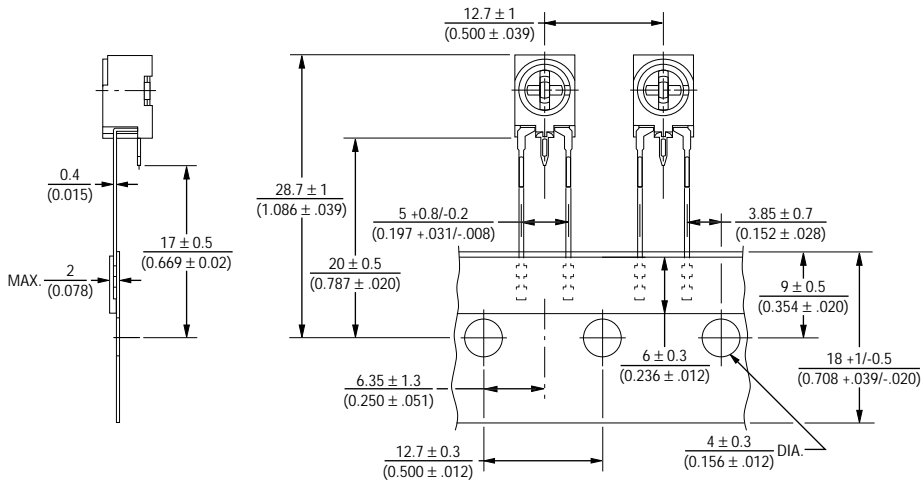

PCB Layout

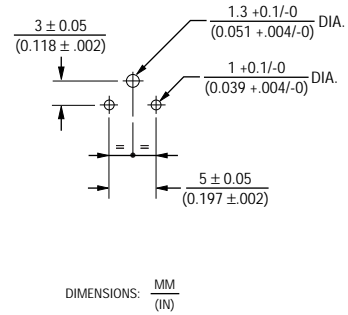

Taped Model TC76N (Preferred)

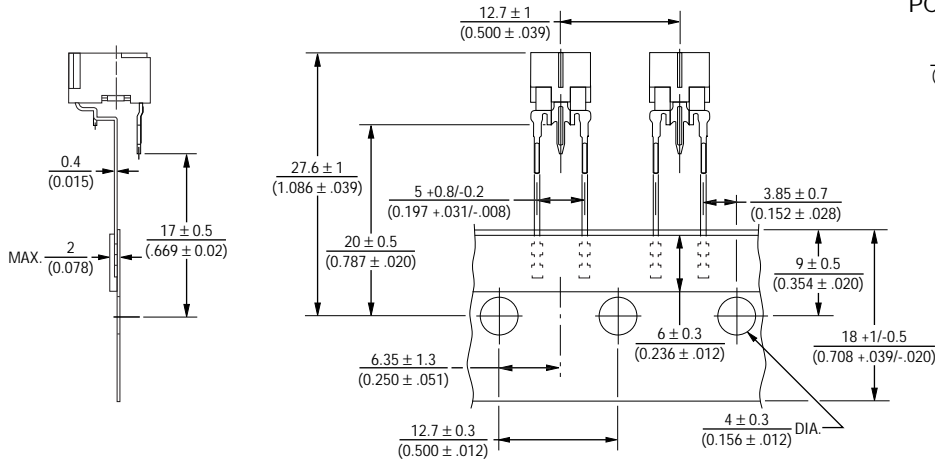

PCB Layout

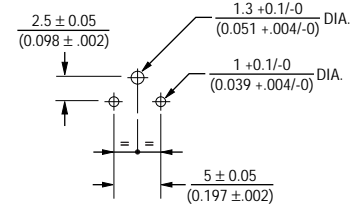

Taped Model TC76G

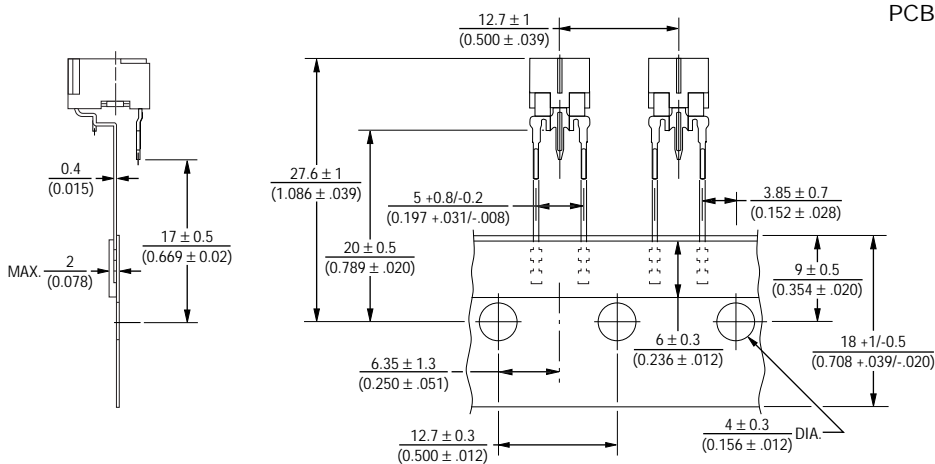

PCB Layout

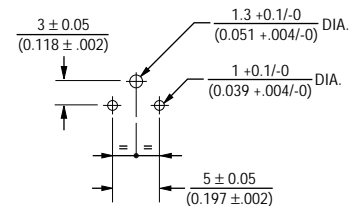

TC76 - 6mm Carbon Trimming Potentiometer

Through-hole Model TC76B preferred

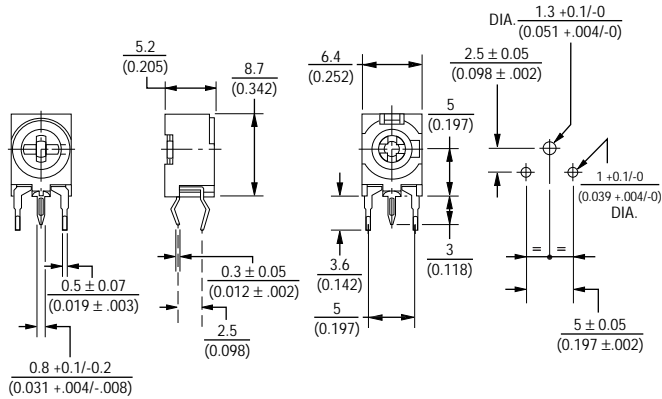

Through-hole Model TC76Z preferred

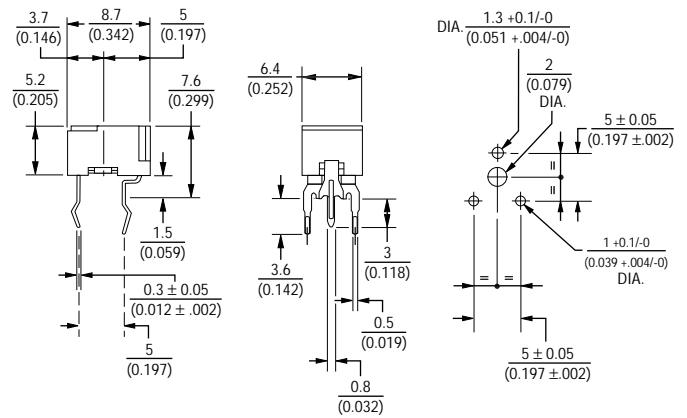

Through-hole Model TC76P

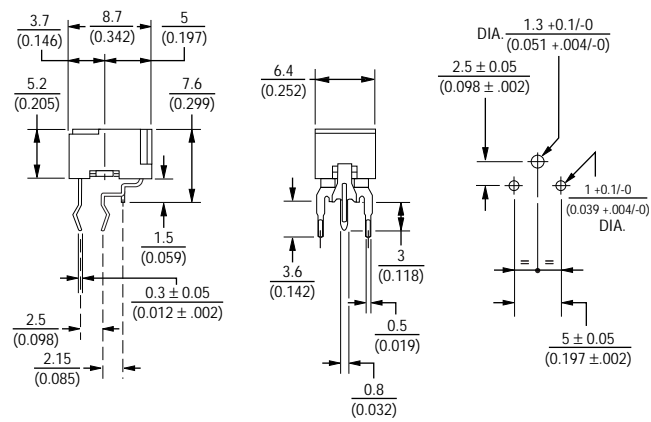

Crimped Terminals detail

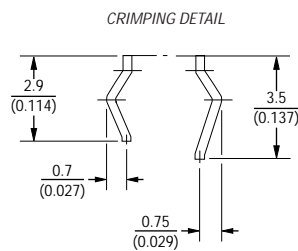



Features

- Dimensions of 6, 8 and 10mm
- Carbon element
- Open frame construction
- Vertical or horizontal adjustment

Applications

- Television sets
- Low cost receivers

TDB06/TDB08/TDB10 - Trimming Potentiometer

Electrical Characteristics

Taper B (linear)
 Standard Resistance Range
 500 ohms to 1M ohm
 (see standard resistance table)
 Resistance Tolerance ±30% std.
 Nominal Resistance Value
 See standard resistance table
 Residual Resistance
 Max. 100 ohms or ±5%

Environmental Characteristics

Power Rating
 TDB06 0.05 watt
 TDB08/10 0.1 watt
 Temperature +5% and -30%
 resistance change
 after 5 hours at 70°C
 Load 5% resistance change max.
 after 3 hours rated load
 Humidity ... 15% resistance change max.
 after 5 hours in 95% RH at 40°
 Load Life ... 20% resistance change max.
 after rated load for 350 hours in
 90% RH at 40°

Physical Characteristics

Mechanical Angle 280° ± 20°
 Rotational Torque 20 - 300 gcm
 Stop-End Strength 0.5 kgcm min.
 Mechanical Strength Base ... 1 kgcm min.
 Contact Force 20g min.
 Rotational Life 15% resistance
 change max. after 100
 rotational life tests
 Soldering Condition 260°C max.
 within 3 seconds

How To Order

TDB 08 - 3 103

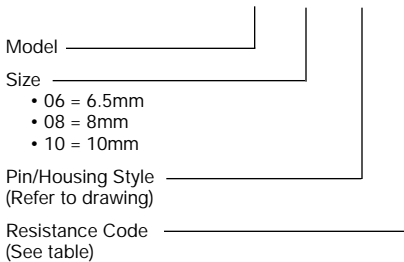

Consult factory for other available options.

TDB06-5
 TDB08-5
 TDB10-4

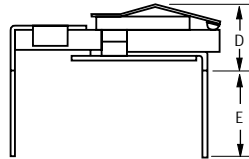
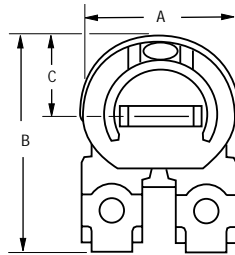

RECOMMENDED PCB LAYOUT

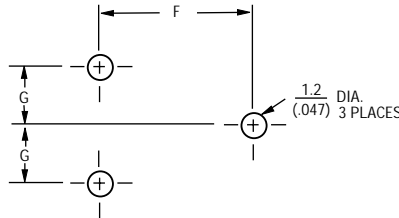

Dimensions

| | TDB-06-5 | TDB-08-5 | TDB-10-4 |
|---|-------------|-------------|--------------|
| A | 6.6 .260 | 8 .315 | 10 .394 |
| B | 7.2 .283 | 11 .433 | 15.3 .602 |
| C | 3.6 .142 | 4 .157 | 7.3 .278 |
| D | 3 .118 | 4 .157 | 5 .197 |
| E | 3.8 .150 | 4 .157 | 4 .157 |
| F | 6.9 .272 | 10 .394 | 15 .590 |
| G | 2.5 .089 | 2.5 .089 | 3.5 .138 |

Standard Resistance Table

| Resistance (Ohms) | Resistance Code |
|-------------------|-----------------|
| 500 | 501 |
| 1,000 | 102 |
| 2,000 | 202 |
| 5,000 | 502 |
| 10,000 | 103 |
| 20,000 | 203 |
| 50,000 | 503 |
| 100,000 | 104 |
| 200,000 | 204 |
| 500,000 | 504 |
| 1,000,000 | 105 |

TDB06-6
 TDB08-3
 TDB10-8

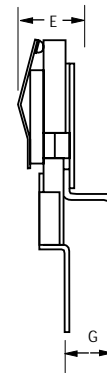
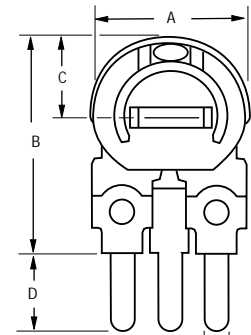

← 1.0
 (.039)
 3 PLACES

RECOMMENDED PCB LAYOUT

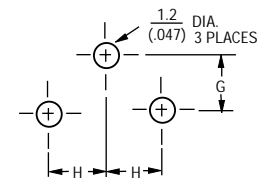

Dimensions

| | TDB-06-6 | TDB-08-3 | TDB-10-8 |
|---|--------------|--------------|--------------|
| A | 6.6 .260 | 8 .315 | 10 .394 |
| B | 7.2 .283 | 11 .433 | 15.3 .602 |
| C | 3.6 .142 | 4 .157 | 7.3 .278 |
| D | 3 .138 | 4 .157 | 5 .275 |
| E | 3.5 .23 | 4 .3 | 7 3.5 |
| F | .090 .089 | .118 .089 | .138 .039 |
| G | 2.5 .089 | 2.5 .089 | 1 .039 |
| H | 2.5 .089 | 2.5 .089 | 5 .197 |







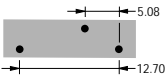

DIMENSIONS ARE: METRIC
 (INCHES)

Specifications are subject to change without notice.

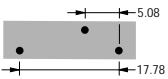
Optional Products

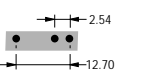
BOURNS®

These optional trimmer products are not recommended for new designs. However, if you require technical specifications, contact a Bourns representative in your area.

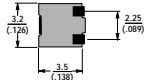
| Model Number | Product | Mounting | | Size | Circuit Board Layout |
|--------------|---|---------------|--------------|------------------|---|
| | | Surface Mount | Through-Hole | | |
| 3005 |  | | • | 3/4" rectangular |  |
| 3009 |  | | • | 3/4" rectangular |  |
| 3082 |  | | • | 1/2" rectangular |  |
| 3345 |  | | • | 1/2" round |  |
| 3373 |  | • | | 3mm square |  |

| Model Number | Turns | | Sealing | Element Tech. | Resistance Range | Power Rating | Tolerance | Mechanical Turns | Adjust | Temp. Range |
|--------------|--------|-------|---------|---------------|----------------------|---|-----------|------------------|-----------|----------------|
| | Single | Multi | | | | | | | | |
| 3005 | | • | Sealed | Wirewound | 10 ohms to 50K ohms | 70°C - 1.0 watts 125°C - 0 watt | ±10% | 20 | Side | -65°C - +125°C |
| 3009 | | • | Sealed | Cermet | 10 ohms to 5 megohms | @ 400 volts max. 70°C - 0.75 watts 150°C - 0 watt | ±10% | 15 | Side | -55°C - +150°C |
| 3082 | | • | Sealed | Cermet | 10 ohms to 2 megohms | @ 400 volts max. 85°C - 0.3 watts 150°C - 0 watt | ±10% | 10 | Side | -65°C - +150°C |
| 3345 | • | | Sealed | Wirewound | 10 ohms to 50K ohms | 70°C - 1.0 watts 150°C - 0 watt | ±5% | 1 | Top, Side | -55°C - +150°C |
| 3373 | • | | Sealed | Cermet | 10 ohms to 2M ohms | 70°C - .125 watts 125°C - 0 watt | ±25% | 1 | Top, Side | -55°C - +125°C |

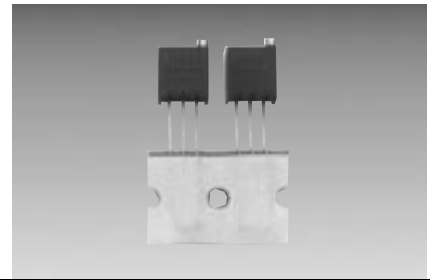
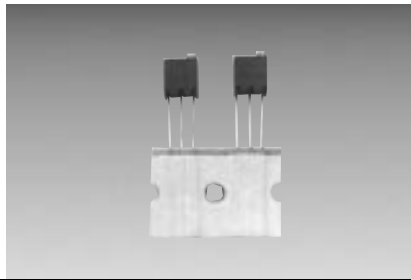

Tape and Reel Packaging Specifications



Now there is a full assortment of Trimpot® Potentiometer models on tape and reel or ammo pack packaging.

- These models are available taped and packaged per EIA Standard 468.
- All models have been tested for compatibility with popular radial insertion machine models on the market today.

How To Order

3362 M - 1 - 103 R

Model _____

Style _____

Standard Product _____

Resistance Code _____

Tape & Reel _____

Designator: Use "R" for Tape & Reel
Use "A" for Ammo Pack



3266*
Product specifications and standard resistance values, page 20.

**SIDE ADJUST
3266Z-1-(RC)R**

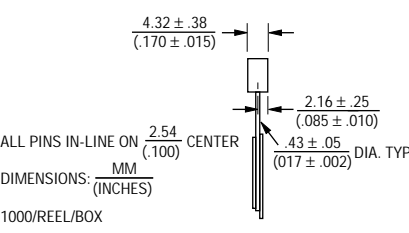
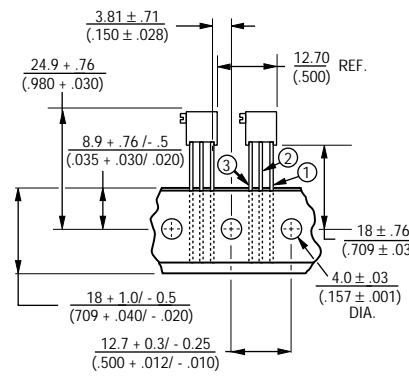

**TOP ADJUST
3266Y-1-(RC)R**

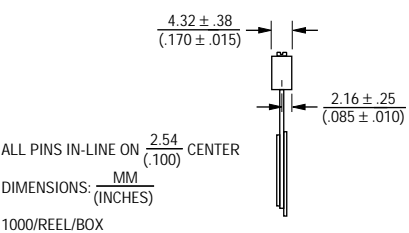
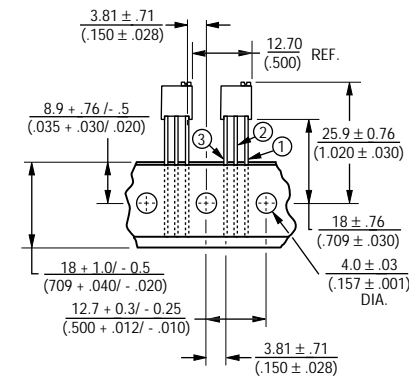

3296*
Product specifications and standard resistance values, page 26.

**SIDE ADJUST
3296X-1-(RC)R**

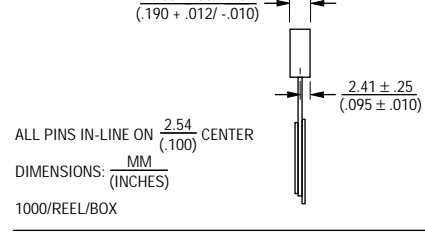
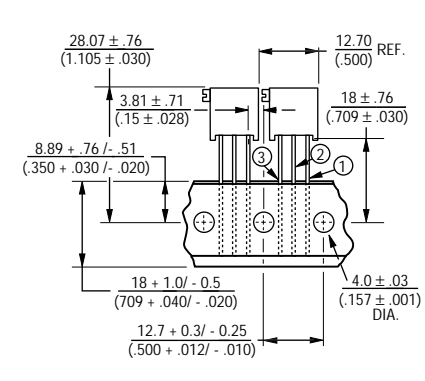

**TOP ADJUST
3296W-1-(RC)R**

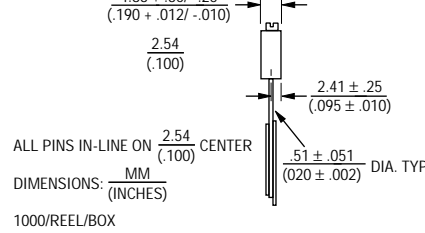
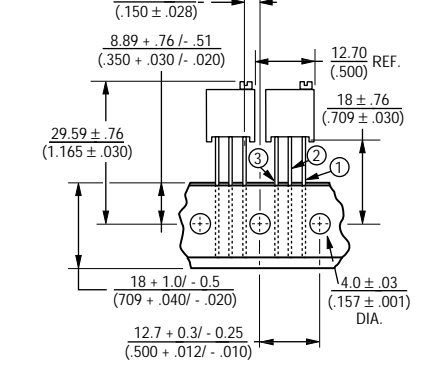

Specifications are subject to change without notice.
*Patented models.

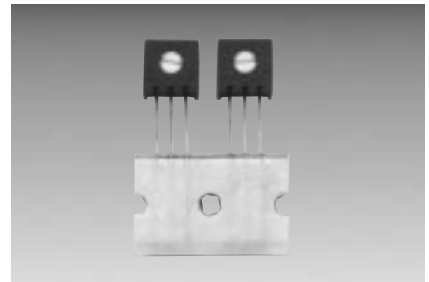
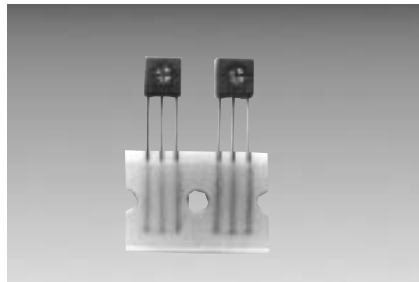
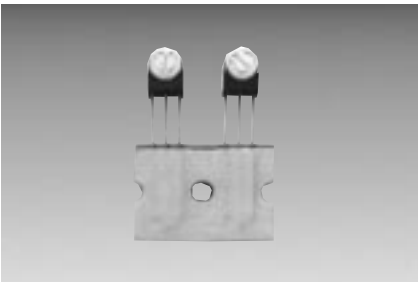

Tape and Reel Packaging Specifications



3329

Product specifications and standard resistance values, page 51.

SIDE ADJUST 3329M-1-(RC)R

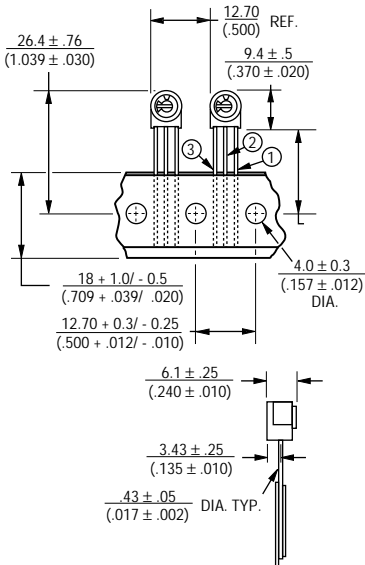

ALL PINS IN-LINE ON $\frac{2.54}{(.100)}$ CENTER
 DIMENSIONS: $\frac{MM}{(INCHES)}$
 1000/REEL/BOX

TOP ADJUST 3329U-1-(RC)R

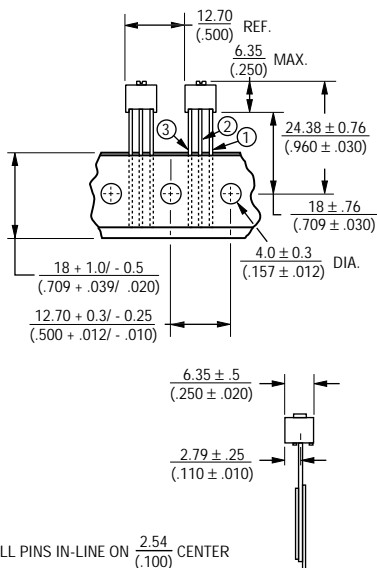

ALL PINS IN-LINE ON $\frac{2.54}{(.100)}$ CENTER
 DIMENSIONS: $\frac{MM}{(INCHES)}$
 1000/REEL/BOX

3362

Product specifications and standard resistance values, pages 54 & 55.

SIDE ADJUST 3362M-1-(RC)R

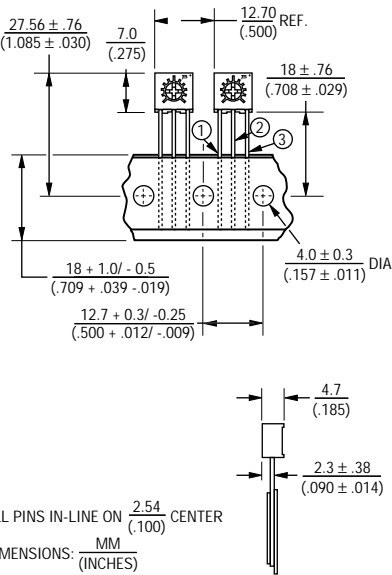

ALL PINS IN-LINE ON $\frac{2.54}{(.100)}$ CENTER
 DIMENSIONS: $\frac{MM}{(INCHES)}$
 1000/REEL/BOX

TOP ADJUST 3362U-1-(RC)R

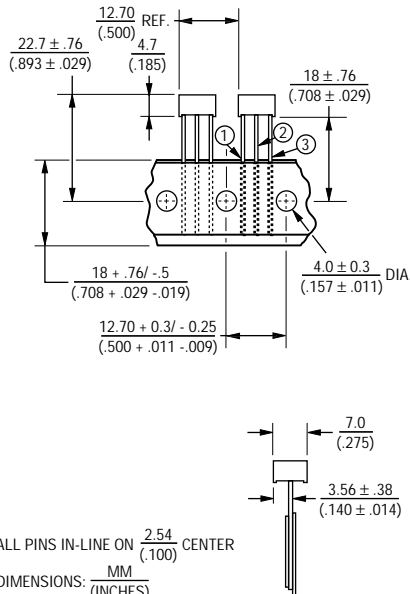

ALL PINS IN-LINE ON $\frac{2.54}{(.100)}$ CENTER
 DIMENSIONS: $\frac{MM}{(INCHES)}$
 750/REEL

3386

Product specifications and standard resistance values, pages 59 & 60.

SIDE ADJUST 3386W-1-(RC)R

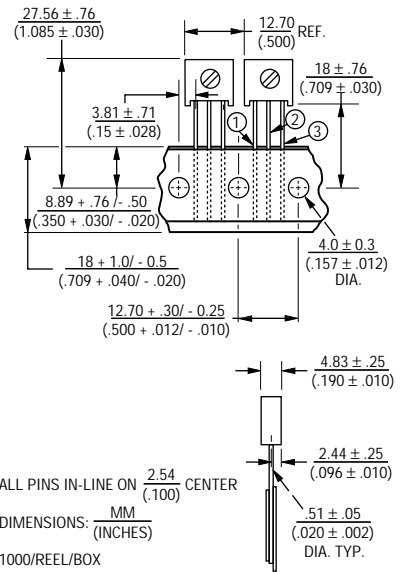

ALL PINS IN-LINE ON $\frac{2.54}{(.100)}$ CENTER
 DIMENSIONS: $\frac{MM}{(INCHES)}$
 1000/REEL/BOX

TOP ADJUST 3386U-1-(RC)R

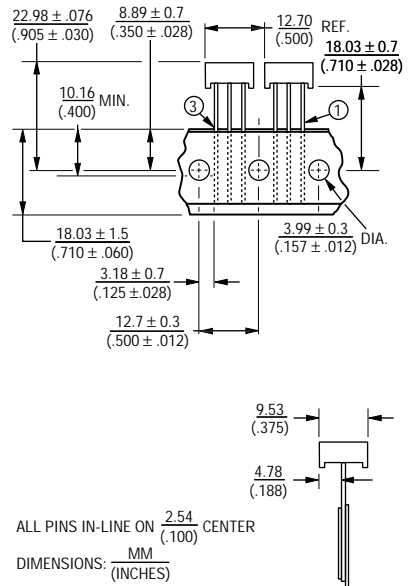

ALL PINS IN-LINE ON $\frac{2.54}{(.100)}$ CENTER
 DIMENSIONS: $\frac{MM}{(INCHES)}$
 1000/REEL/BOX

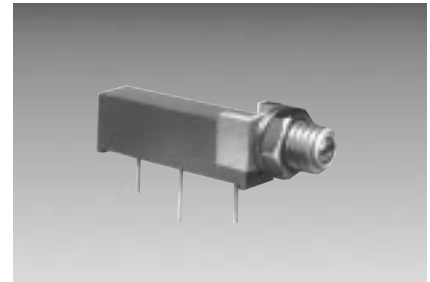
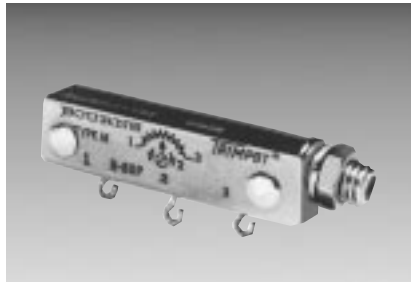

Factory Installed Panel Mount **BOURNS®**

TRIMPOT® POTENTIOMETER PANEL MOUNTING OPTIONS AND HARDWARE

Many Trimpot® Potentiometers are available for panel mount application.

This product option provides for maximum design flexibility.

To order Trimpot® Potentiometers with panel mount hardware attached by the factory, simply add an "M" or "Z" suffix to the Bourns part number per Table I, page 75.

Example:
3006P-1-100Z

To order military Trimpot® Potentiometers with panel mount hardware attached by the factory, order the military part number and add "with panel mount attached."

Example:
RT12C2PRC, with panel mount attached.

To order panel mounting accessories for customer installation, simply use the part number per Table II, page 75.

Example:
H83P

NOTE: For complete product specifications, see catalog page for the trimmer model.

Torque - Apply maximum 8 in. lbs. on mounting nut when mounted on panel.

Models RT12/RJ12, 3057/3059

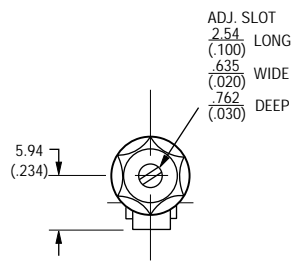
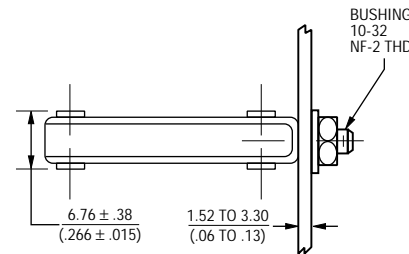
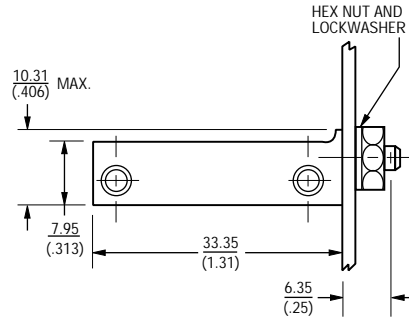

- NOTES:
1. PROVIDED WITH LOCKWASHER AND MOUNTING NUT.
 2. RECOMMEND PANEL HOLES. #10 DRILL $\frac{.194}{(.008)}$

Models 3005/3006/3009

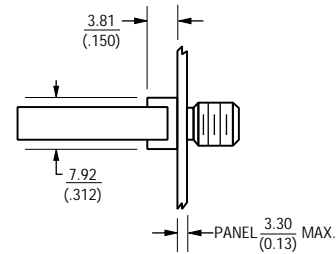
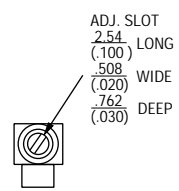
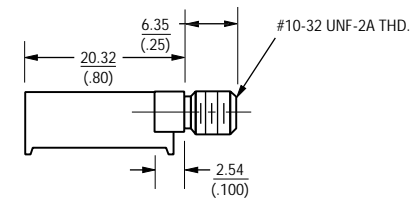

- NOTES:
1. PROVIDED WITH LOCKWASHER AND MOUNTING NUT.
 2. RECOMMEND PANEL HOLE SIZE #7 DRILL $\frac{.200}{(.008)}$

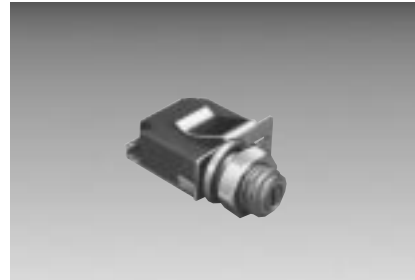

Factory Installed Panel Mount

BOURNS®

Models 3292

X, L and W Styles

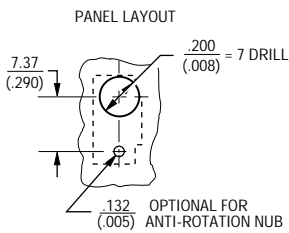
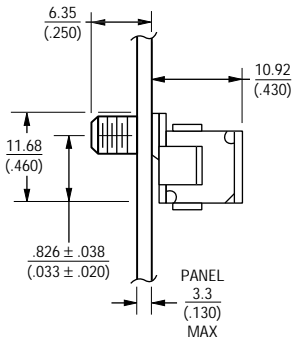
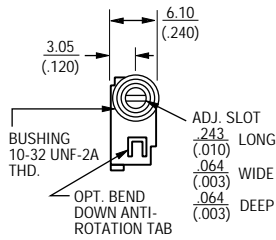

NOTES:
1. PROVIDED WITH LOCKWASHER AND MOUNTING NUT.

Models RT22/RTR22/RJ22 3250/3252

Models RT24/RTR24/3290

H and W Styles - 3290 X & W Styles- RT24/RTR24

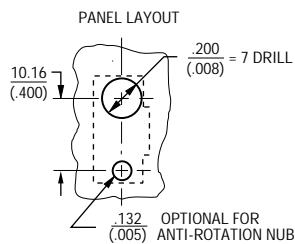
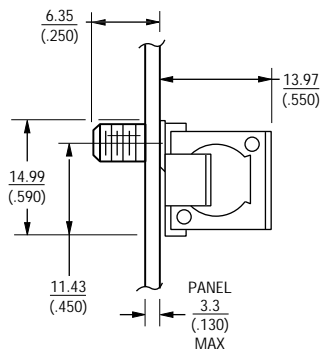
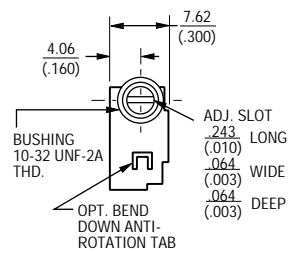

NOTES:
1. PROVIDED WITH LOCKWASHER AND MOUNTING NUT.

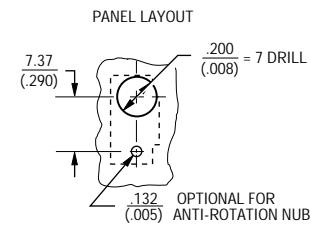
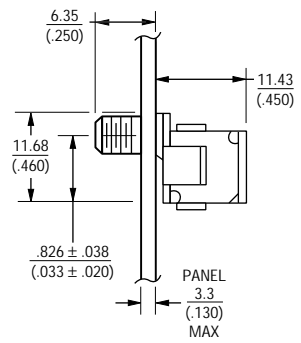
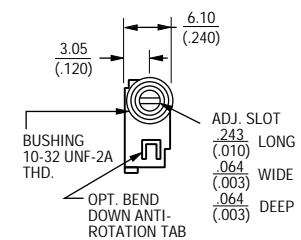

NOTES:
1. PROVIDED WITH LOCKWASHER AND MOUNTING NUT.

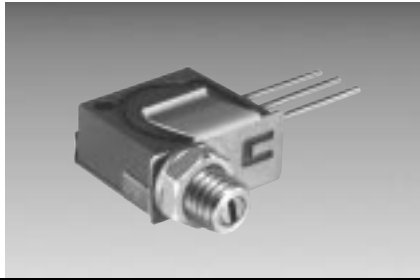
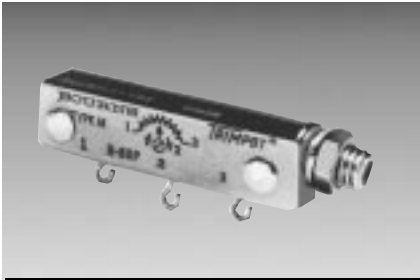

Customer Installed Panel Mount - Unsealed



SEE TABLE II (PAGE 75) FOR PANEL MOUNT PART NUMBER

H-58P Panel Mount

1-1/4 Inch Rectangular
Multiturn Modules

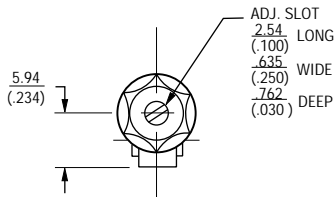
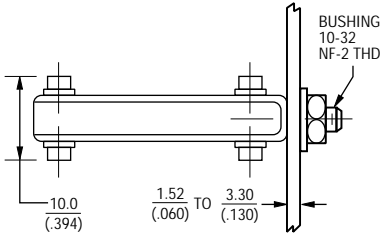
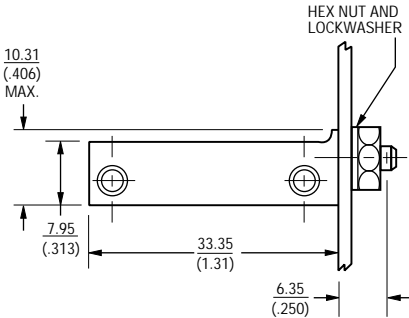

NOTES:

1. PROVIDED WITH LOCKWASHER AND MOUNTING NUT.
2. RECOMMEND PANEL HOLES. #10 DRILL $\frac{.194}{.008}$

*SPECIFY H82 IF PANEL SEAL IS REQUIRED.

H-65P Panel Mount

1/2 Inch Square
Multiturn Models

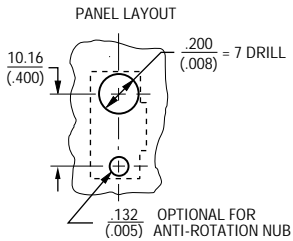
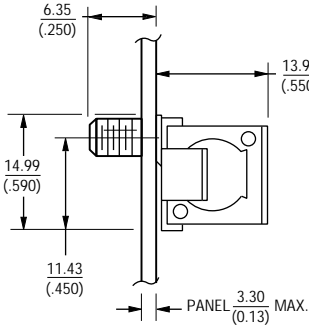
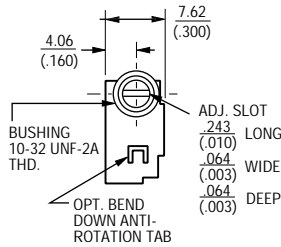

NOTES:

1. PROVIDED WITH LOCKWASHER AND MOUNTING NUT.
2. DRAWINGS SHOWN WITH TRIMMER. ORDER PART SEPARATELY

H-83P Panel Mount

Adapter for Models 3005 AND 3006

The H-83P Adapter is used with Models 3005 (page 69) and 3006 (page 9). Order separately and simply snap fit the trimmer in the plastic case. The H-83P with lock-washer and mounting nut is available in 50-piece lots.

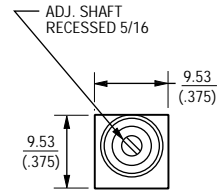
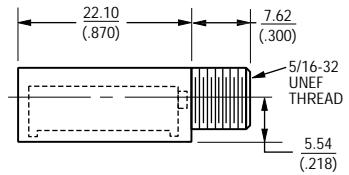
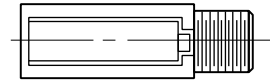

NOTES:

1. DRAWINGS SHOWN WITH TRIMMER. ORDER PART SEPARATELY

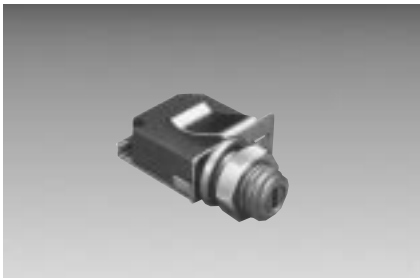

Customer Installed Panel Mount



3/8 Inch Square Multiturn Models

H-114P/115P/116P Panel Mount

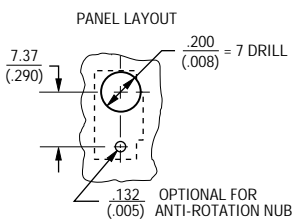
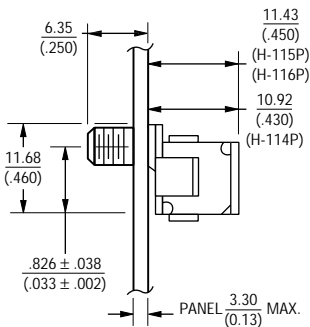
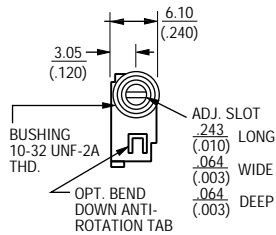

NOTES:

1. PROVIDED WITH LOCKWASHER AND MOUNTING NUT.
2. DRAWINGS SHOWN WITH TRIMMER. ORDER PART SEPARATELY

TABLE I
FACTORY INSTALLED PANEL MOUNTS

| STANDARD PART NO. | PART NO. WITH PANEL MOUNT |
|------------------------|---------------------------|
| 3005P-1-(RC) | 3005P-1-(RC) Z |
| 3006P,Y, or W-1-(RC) | 3006P,Y, or W-1-(RC) Z |
| 3009P or Y-1-(RC) | 3009P or Y-1-(RC) Z |
| 3057L,J,P, or Y-1-(RC) | 3057L,J,P, or Y-1-(RC) M |
| 3059L,J,P, or Y-1-(RC) | 3059L,J,P, or Y-1-(RC) M |
| 3250L or W-1-(RC) | 3250L or W-1-(RC) M |
| 3252L or W-1-(RC) | 3252L or W-1-(RC) M |
| 3290 H or W-1-(RC) | 3290H or W-1-(RC) M |
| 3292L,W, or X-1-(RC) | 3292L,W, or X-1-(RC) M |

TABLE II
RETRO-FIT PANEL MOUNTS FOR INSTALLATION BY CUSTOMER

| STANDARD PART NO. | ORDER PANEL MOUNT PART NO. |
|-------------------------|----------------------------|
| 3005P-1-(RC) | H-83P |
| 3006P,Y, or W-1-(RC) | H-83P |
| 3057L,J,P, or Y-1-(RC) | H-58P* SCREW ASSEMBLY |
| 3059L,J,P, or Y-1-(RC) | H-58P* SCREW ASSEMBLY |
| 3250L, W, X-(RC) | H-65P-1* |
| 3252L or W-1-(RC) | H-65P-3* |
| 3252X-1-(RC) | H-65P-5* |
| 3290 H or W-1-(RC) | H-114P* |
| 3292L-1-(RC) | H-115P* |
| 3292W OR X-1-(RC) | H-116P* |
| RT12P,Y,L | H-58P* SCREW ASSEMBLY |
| RJ12L,P,Y | H-58P* SCREW ASSEMBLY |
| RT22L,W, X, RTR22L,W, X | H-65P-1* |
| RJ22L,W | H-65P-3* |
| RJ22X | H-65P-5* |
| RT24W / RTR24W OR X | H-114P* |
| RJR24W OR X | H-116P* |

*Specify H-82 if panel seal is required.

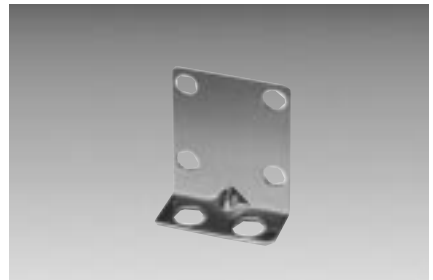
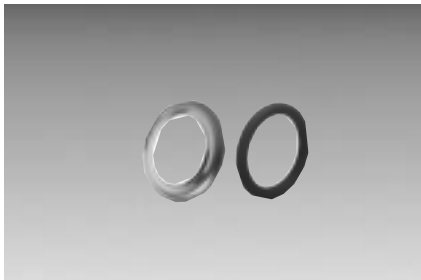

Hardware For Special Mounting Applications **BOURNS®**

H-82 Panel Seal

For all panel mounts with size 10-32 bushings.

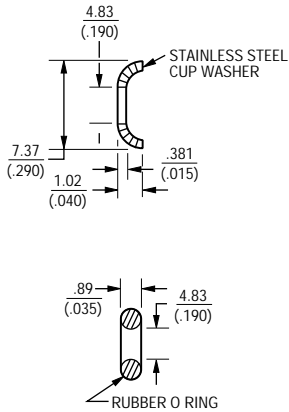

To be used with the following to provide panel seal:

- H-58P
- H-65P-1
- H-65P-3
- H-65P-5
- H-114P
- H-115P
- H-116P

H-25/H-28 Stacking Straps

Models 3250, 3252 (H-25) and 3292 (H-28).

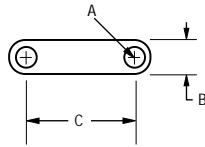

| DIMENSIONS | H-25 | H-28 |
|------------|-----------------|-----------------|
| A | .236 (.093) | .178 (.070) |
| B | .363 (.143) | .318 (.125) |
| C | 1.321 (.520) | 1.064 (.419) |
| THICKNESS | .51 (.02) | |

H-26S Side Bracket

Models 3250 and 3252
This hardware is available for special mounting applications.

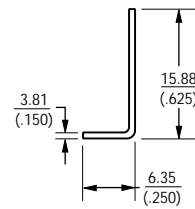
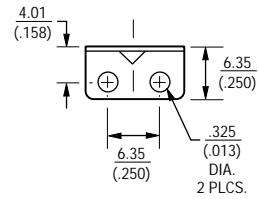
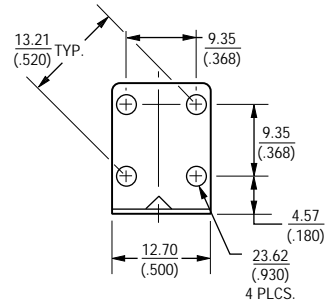



Features

- Meets UL 94V-0
- Pocket clip
- For use on most trimmer shafts/rotors
- Recessed end for use with extended shafts

H-90/H-91 - Adjustment Tools

H-90

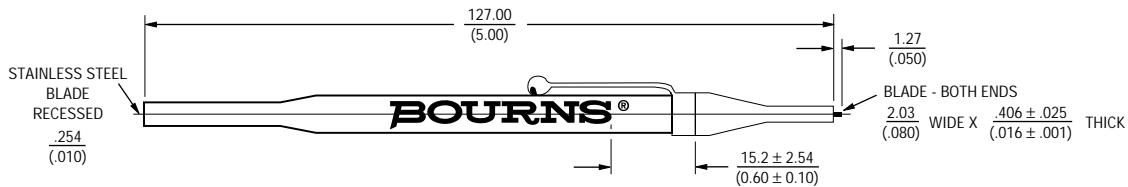

H-91*

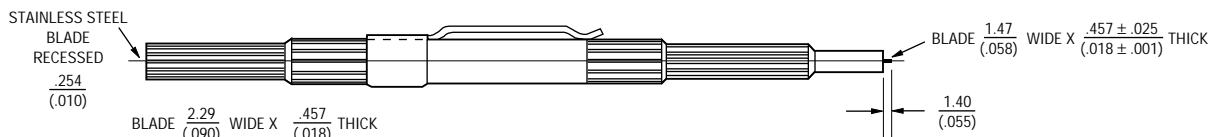

*H-91 RECOMMENDED FOR USE WITH TRIMMER MODELS 3224 AND 3214.



- Wide assortment of popular trimmers
- Convenient, easy-to-use packaging
- Single-turn and multiturn styles
- Many configurations in both cermet and wirewound element types

H-800 TrimBin™ Trimmer Lab Design Kit

A complete assortment of the most popular through-hole trimmer styles from Bourns Trimpot is contained in one convenient package. The kit contains 126 parts representing 50 varieties of resistances and pin styles.

Select the size, shape, type of element, and method of adjustment to suit your application.



- Full line of surface mount products
- Convenient, easy-to-use packaging
- Single-turn, multiturn, sealed, open-frame styles
- Popular styles and ohmic values

H-814 Surface Mount Lab Design Kit

A complete assortment of the most popular surface mount products from Bourns Trimpot is contained in this convenient lab design kit. It contains 220 parts in popular styles and resistance values to help in your design selection.

Also included are complete performance parameters and specifications for each model in the kit. Plus, a convenient Adjustment Tool.



Features

- High intensity Xenon beam
- Two tool tip sizes
- Red and blue/green vision aid lenses
- Approved for hazardous location use

H-200 - Adjustment Tool with a Light

TrimBeam™

Makes It Easy to See and Access Small Electronic Components

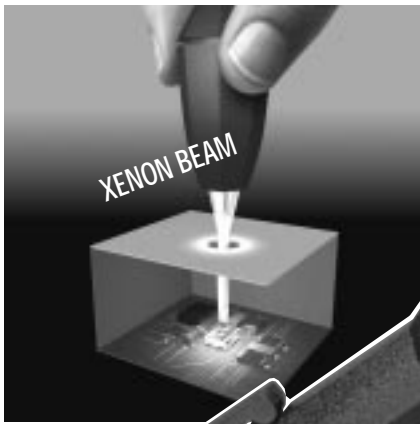

Twist the Head to Turn Light On/Off

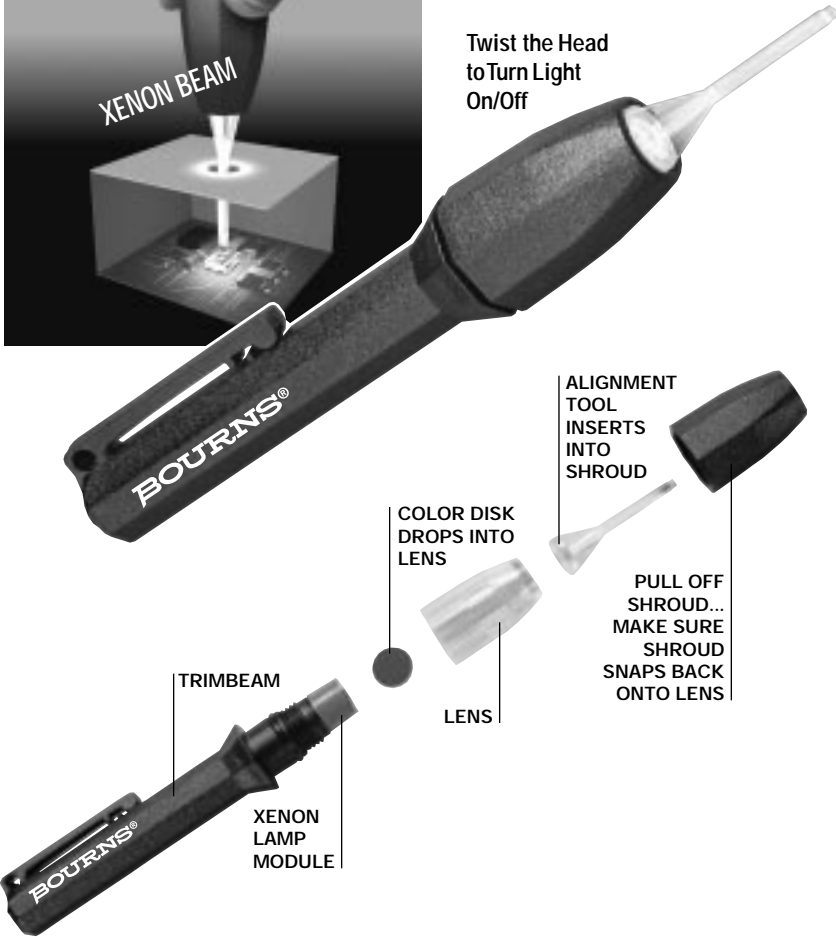

ALIGNMENT TOOL INSERTS INTO SHROUD

COLOR DISK DROPS INTO LENS

PULL OFF SHROUD... MAKE SURE SHROUD SNAPS BACK ONTO LENS

TRIMBEAM

XENON LAMP MODULE

LENS

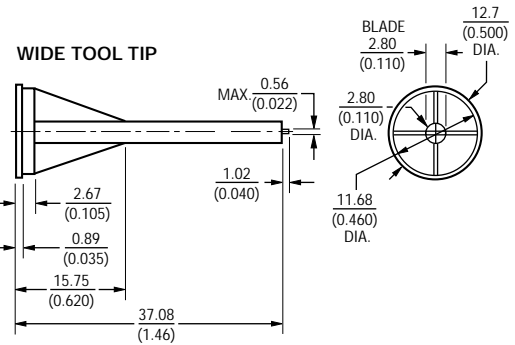
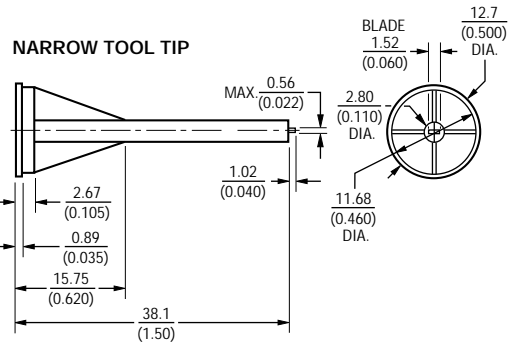
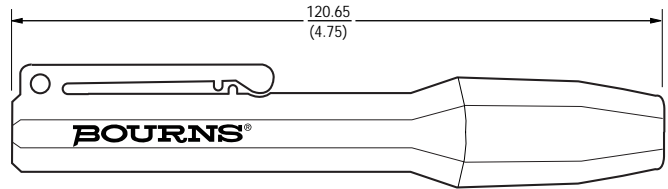

Mil-Spec Numbering System - Defined



Non-Wirewound RJ Styles

MIL-R-22097 **RJ24 F W 103**

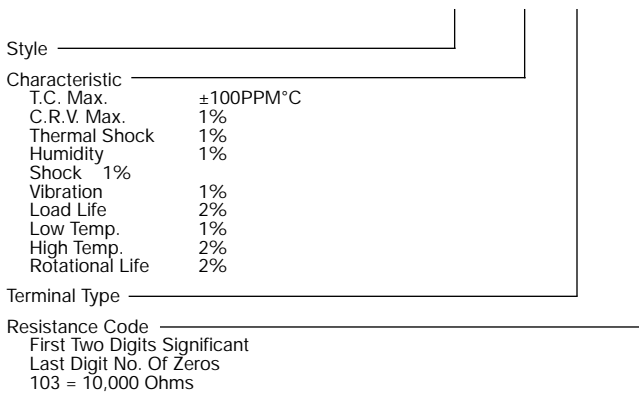

Non-Wirewound RJR Styles - High Reliability

MIL-R-39035 **RJR24 F W 102 P**

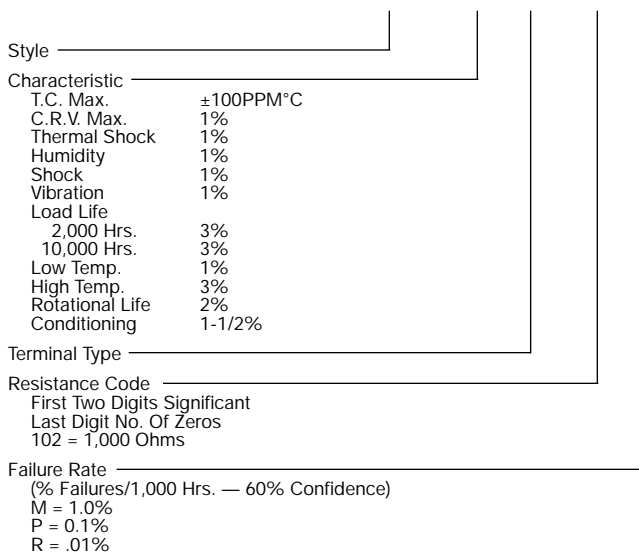

Wirewound RT Styles

MIL-R-27208 **RT24 C2 P 101**

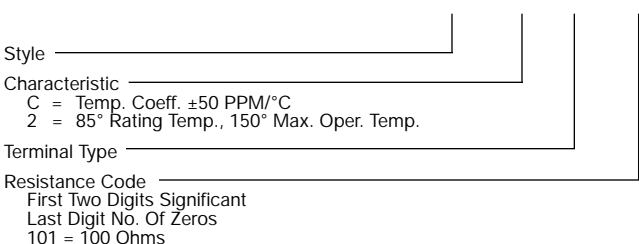

High-Rel Wirewound Specification MIL-R-39015 RTR Styles

This specification has a procedure for ordering, processing, and marking parts entirely different than the other three specifications. IT DOES NOT USE THE TYPE DESIGNATION NUMBER AS THE PART NUMBER.

THE NUMBER TO ORDER BY CONSISTS OF:

- The individual specification sheet number
 M39015/2 (FOR STYLE RTR22)
 M39015/3 (FOR STYLE RTR24)
- A dash number from the specification sheet table for the resistance value

| | |
|----------|-----------|
| M39015/2 | M39015/3 |
| -003 500 | - 006 500 |
| -004 1K | - 007 1K |
| -005 2K | - 008 2K |
| -006 5K | - 009 5K |
| -007 10K | - 010 10K |
| -008 20K | |
- Terminal Type
- Failure rate level M
 M = 1%
 % FAILURE/1,000 Hrs. — 60% Confidence

EXAMPLES OF PART NUMBERS

M39015/2 — **006LM**
 5K Term. Type L — Failure Rate M

M39015/3 — **010XM**
 10K Term. Type X — Failure Rate M

The table on the next page shows all part numbers covered by this specification, the conversion to the RTR type designation number required by the supplier to manufacture the part, and the number that will be marked on the units you receive (same as part number ordered but with the letter "J" in front of it). The letter "J" is a government mark and it is certification that the parts comply with the specification.

INFORMATION NOTES

- M39015/3 WAS ADDED TO THE MIL-SPEC AFTER ITS ORIGINAL RELEASE.

Mil-Spec Numbering System - How To Order



Bourns High Reliability Mil-Spec Part Numbers

| Order By | Process By* | Marked With | Terminal Types | Failure Rates |
|--|---|---|----------------|---------------|
| M39015/2-003(TS)(FR) M39015/2-004(TS)(FR) M39015/2-005(TS)(FR) | RTR22D(TS)501(FR) RTR22D(TS)102(FR) RTR22D(TS)202(FR) | JM39015/2-003(TS)(FR) JM39015/2-004(TS)(FR) JM39015/2-005(TS)(FR) | L, P, W, X | M |
| M39015/2-006(TS)(FR) M39015/2-007(TS)(FR) M39015/2-008(TS)(FR) | RTR22D(TS)502(FR) RTR22D(TS)103(FR) RTR22D(TS)203(FR) | JM39015/2-006(TS)(FR) JM39015/2-007(TS)(FR) JM39015/2-008(TS)(FR) | | |
| M39015/3-006(TS)(FR) | RTR24D(TS)501(FR) | JM39015/3-006(TS)(FR) | P, W, X | M |
| M39015/3-007(TS)(FR) M39015/3-008(TS)(FR) | RTR24D(TS)102(FR) RTR24D(TS)202(FR) | JM39015/3-007(TS)(FR) JM39015/3-008(TS)(FR) | P, W, X | M |
| M39015/3-009(TS)(FR) M39015/3-010(TS)(FR) | RTR24D(TS)502(FR) RTR24D(TS)103(FR) | JM39015/3-009(TS)(FR) JM39015/3-010(TS)(FR) | | |

*May also order using this part number.

Qualified Part Numbers

Bourns reserves the right per MIL-R-39035 to substitute a higher grade temperature characteristic or failure rate (QPL) than requested.

RT/RTR22 (Commercial Model 3250)

| STD. VALUES OHMS | RT22C2_____ | | | | RTR22D_____ | | | | NOMINAL RESOLUTION (PERCENT) |
|------------------|-------------|------------|------------|------------|-------------|-------------|-------------|-------------|------------------------------|
| | L | P | W | X | L | P | W | X | |
| 10 | - | - | - | - | - | - | - | - | - |
| 20 | - | - | - | - | - | - | - | - | - |
| 50 | RT22C2L500 | RT22C2P500 | RT22C2W500 | RT22C2X500 | - | - | - | - | 0.80 |
| 100 | RT22C2L101 | RT22C2P101 | RT22C2W101 | RT22C2X101 | - | - | - | - | 0.90 |
| 200 | RT22C2L201 | RT22C2P201 | RT22C2W201 | RT22C2X201 | - | - | - | - | 0.70 |
| 500 | RT22C2L501 | RT22C2P501 | RT22C2W501 | RT22C2X501 | RTR22DL501M | RTR22DP501M | RTR22DW501M | RTR22DX501M | 0.60 |
| 1K | RT22C2L102 | RT22C2P102 | RT22C2W102 | RT22C2X102 | RTR22DL102M | RTR22DP102M | RTR22DW102M | RTR22DX102M | 0.40 |
| 2K | RT22C2L202 | RT22C2P202 | RT22C2W202 | RT22C2X202 | RTR22DL202M | RTR22DP202M | RTR22DW202M | RTR22DX202M | 0.30 |
| 5K | RT22C2L502 | RT22C2P502 | RT22C2W502 | RT22C2X502 | RTR22DL502M | RTR22DP502M | RTR22DW502M | RTR22DX502M | 0.25 |
| 10K | RT22C2L103 | RT22C2P103 | RT22C2W103 | RT22C2X103 | RTR22DL103M | RTR22DP103M | RTR22DW103M | RTR22DX103M | 0.19 |
| 20K | RT22C2L203 | RT22C2P203 | RT22C2W203 | RT22C2X203 | RTR22DL203M | RTR22DP203M | RTR22DW203M | RTR22DX203M | 0.16 |

Qualified Part Numbers



Bourns reserves the right per MIL-R-39035 to substitute a higher grade temperature characteristic or failure rate (QPL) than requested.

RT/RTR24 (Commercial Model 3290)

| STD. VALUES OHMS | RT24C2_____ | | | RTR24D_____ | | | NOMINAL RESOLUTION (PERCENT) |
|------------------|-------------|------------|------------|-------------|-------------|-------------|------------------------------|
| | P | W | X | P | W | X | |
| 10 | RT24C2P100 | RT24C2W100 | RT24C2X100 | - | - | - | 1.11 |
| 20 | RT24C2P200 | RT24C2W200 | RT24C2X200 | - | - | - | 0.93 |
| 50 | RT24C2P500 | RT24C2W500 | RT24C2X500 | - | - | - | 0.62 |
| 100 | RT24C2P101 | RT24C2W101 | RT24C2X101 | - | - | - | 0.60 |
| 200 | RT24C2P201 | RT24C2W201 | RT24C2X201 | - | - | - | 0.54 |
| 500 | RT24C2P501 | RT24C2W501 | RT24C2X501 | RTR24DP501M | RTR24DW501M | RTR24DX501M | 0.42 |
| 1K | RT24C2P102 | RT24C2W102 | RT24C2X102 | RTR24DP102M | RTR24DW102M | RTR24DX102M | 0.33 |
| 2K | RT24C2P202 | RT24C2W202 | RT24C2X202 | RTR24DP202M | RTR24DW202M | RTR24DX202M | 0.26 |
| 5K | RT24C2P502 | RT24C2W502 | RT24C2X502 | RTR24DP502M | RTR24DW502M | RTR24DX502M | 0.20 |
| 10K | RT24C2P103 | RT24C2W103 | RT24C2X103 | RTR24DP103M | RTR24DW103M | RTR24DX103M | 0.17 |

RT26 (Commercial Model 3260)

| STD. VALUES OHMS | RT26C2_____ | | NOMINAL RESOLUTION (PERCENT) |
|------------------|-------------|------------|------------------------------|
| | W | X | |
| 10 | RT26C2W100 | RT26C2X100 | 1.90 |
| 20 | RT26C2W200 | RT26C2X200 | 1.50 |
| 50 | RT26C2W500 | RT26C2X500 | 1.25 |
| 100 | RT26C2W101 | RT26C2X101 | 1.00 |
| 200 | RT26C2W201 | RT26C2X201 | 0.94 |
| 500 | RT26C2W501 | RT26C2X501 | 0.58 |
| 1K | RT26C2W102 | RT26C2X102 | 0.50 |
| 2K | RT26C2W202 | RT26C2X202 | 0.45 |
| 5K | RT26C2W502 | RT26C2X502 | 0.34 |

FAILURE RATE LEVEL M = 1.0%

RJ24 (Commercial Model 3296)

| STD. VALUES OHMS | RJ24F_____ | | |
|------------------|------------|-----------|-----------|
| | P | W | X |
| 10 | RJ24FP100 | RJ24FW100 | RJ24FX100 |
| 20 | RJ24FP200 | RJ24FW200 | RJ24FX200 |
| 50 | RJ24FP500 | RJ24FW500 | RJ24FX500 |
| 100 | RJ24FP101 | RJ24FW101 | RJ24FX101 |
| 200 | RJ24FP201 | RJ24FW201 | RJ24FX201 |
| 500 | RJ24FP501 | RJ24FW501 | RJ24FX501 |
| 1K | RJ24FP102 | RJ24FW102 | RJ24FX102 |
| 2K | RJ24FP202 | RJ24FW202 | RJ24FX202 |
| 5K | RJ24FP502 | RJ24FW502 | RJ24FX502 |
| 10K | RJ24FP103 | RJ24FW103 | RJ24FX103 |
| 20K | RJ24FP203 | RJ24FW203 | RJ24FX203 |
| 25K | RJ24FP253 | RJ24FW253 | RJ24FX253 |
| 50K | RJ24FP503 | RJ24FW503 | RJ24FX503 |
| 100K | RJ24FP104 | RJ24FW104 | RJ24FX104 |
| 250K | RJ24FP254 | RJ24FW254 | RJ24FX254 |
| 500K | RJ24FP504 | RJ24FW504 | RJ24FX504 |
| 1 MEG | RJ24FP105 | RJ24FW105 | RJ24FX105 |

FAILURE RATE LEVEL M = 1.0%

RJ22 (Commercial Model 3252)

| STD. VALUES OHMS | RJ22F_____ | | | |
|------------------|------------|-----------|-----------|-----------|
| | L | P | W | X |
| 10 | RJ22FL100 | RJ22FP100 | RJ22FW100 | RJ22FX100 |
| 20 | RJ22FL200 | RJ22FP200 | RJ22FW200 | RJ22FX200 |
| 50 | RJ22FL500 | RJ22FP500 | RJ22FW500 | RJ22FX500 |
| 100 | RJ22FL101 | RJ22FP101 | RJ22FW101 | RJ22FX101 |
| 200 | RJ22FL201 | RJ22FP201 | RJ22FW201 | RJ22FX201 |
| 500 | RJ22FL501 | RJ22FP501 | RJ22FW501 | RJ22FX501 |
| 1K | RJ22FL102 | RJ22FP102 | RJ22FW102 | RJ22FX102 |
| 2K | RJ22FL202 | RJ22FP202 | RJ22FW202 | RJ22FX202 |
| 5K | RJ22FL502 | RJ22FP502 | RJ22FW502 | RJ22FX502 |
| 10K | RJ22FL103 | RJ22FP103 | RJ22FW103 | RJ22FX103 |
| 20K | RJ22FL203 | RJ22FP203 | RJ22FW203 | RJ22FX203 |
| 25K | RJ22FL253 | RJ22FP253 | RJ22FW253 | RJ22FX253 |
| 50K | RJ22FL503 | RJ22FP503 | RJ22FW503 | RJ22FX503 |
| 100K | RJ22FL104 | RJ22FP104 | RJ22FW104 | RJ22FX104 |
| 250K | RJ22FL254 | RJ22FP254 | RJ22FW254 | RJ22FX254 |
| 500K | RJ22FL504 | RJ22FP504 | RJ22FW504 | RJ22FX504 |
| 1 MEG | RJ22FL105 | RJ22FP105 | RJ22FW105 | RJ22FX105 |

Qualified Part Numbers



Bourns reserves the right per MIL-R-39035 to substitute a higher grade temperature characteristic or failure rate (QPL) than requested.

RJR24 (Commercial Model 3296)

| STD. VALUES OHMS | RJ24F _____ | | |
|------------------|-------------|-------------|-------------|
| | P | W | X |
| 10 | RJR24FP100* | RJR24FW100* | RJR24FX100* |
| 20 | RJR24FP200* | RJR24FW200* | RJR24FX200* |
| 50 | RJR24FP500* | RJR24FW500* | RJR24FX500* |
| 100 | RJR24FP101* | RJR24FW101* | RJR24FX101* |
| 200 | RJR24FP201* | RJR24FW201* | RJR24FX201* |
| 500 | RJR24FP501* | RJR24FW501* | RJR24FX501* |
| 1K | RJR24FP102* | RJR24FW102* | RJR24FX102* |
| 2K | RJR24FP202* | RJR24FW202* | RJR24FX202* |
| 5K | RJR24FP502* | RJR24FW502* | RJR24FX502* |
| 10K | RJR24FP103* | RJR24FW103* | RJR24FX103* |
| 20K | RJR24FP203* | RJR24FW203* | RJR24FX203* |
| 25K | RJR24FP253* | RJR24FW253* | RJR24FX253* |
| 50K | RJR24FP503* | RJR24FW503* | RJR24FX503* |
| 100K | RJR24FP104* | RJR24FW104* | RJR24FX104* |
| 250K | RJR24FP254* | RJR24FW254* | RJR24FX254* |
| 500K | RJR24FP504* | RJR24FW504* | RJR24FX504* |
| 1 MEG | RJR24FP105* | RJR24FW105* | RJR24FX105* |

RJ/RJR26 (Commercial Model 3262)

| STD. VALUES OHMS | RJ26F _____ | | | RJ26F _____ | | |
|------------------|-------------|-----------|-----------|-------------|-------------|-------------|
| | P | W | X | P | W | X |
| 10 | RJ26FP100 | RJ26FW100 | RJ26FX100 | RJR26FP100* | RJR26FW100* | RJR26FX100* |
| 20 | RJ26FP200 | RJ26FW200 | RJ26FX200 | RJR26FP200* | RJR26FW200* | RJR26FX200* |
| 50 | RJ26FP500 | RJ26FW500 | RJ26FX500 | RJR26FP500* | RJR26FW500* | RJR26FX500* |
| 100 | RJ26FP101 | RJ26FW101 | RJ26FX101 | RJR26FP101* | RJR26FW101* | RJR26FX101* |
| 200 | RJ26FP201 | RJ26FW201 | RJ26FX201 | RJR26FP201* | RJR26FW201* | RJR26FX201* |
| 500 | RJ26FP501 | RJ26FW501 | RJ26FX501 | RJR26FP501* | RJR26FW501* | RJR26FX501* |
| 1K | RJ26FP102 | RJ26FW102 | RJ26FX102 | RJR26FP102* | RJR26FW102* | RJR26FX102* |
| 2K | RJ26FP202 | RJ26FW202 | RJ26FX202 | RJR26FP202* | RJR26FW202* | RJR26FX202* |
| 5K | RJ26FP502 | RJ26FW502 | RJ26FX502 | RJR26FP502* | RJR26FW502* | RJR26FX502* |
| 10K | RJ26FP103 | RJ26FW103 | RJ26FX103 | RJR26FP103* | RJR26FW103* | RJR26FX103* |
| 20K | RJ26FP203 | RJ26FW203 | RJ26FX203 | RJR26FP203* | RJR26FW203* | RJR26FX203* |
| 25K | RJ26FP253 | RJ26FW253 | RJ26FX253 | RJR26FP253* | RJR26FW253* | RJR26FX253* |
| 50K | RJ26FP503 | RJ26FW503 | RJ26FX503 | RJR26FP503* | RJR26FW503* | RJR26FX503* |
| 100K | RJ26FP104 | RJ26FW104 | RJ26FX104 | RJR26FP104* | RJR26FW104* | RJR26FX104* |
| 250K | RJ26FP254 | RJ26FW254 | RJ26FX254 | RJR26FP254* | RJR26FW254* | RJR26FX254* |
| 500K | RJ26FP504 | RJ26FW504 | RJ26FX504 | RJR26FP504* | RJR26FW504* | RJR26FX504* |
| 1 MEG | RJ26FP105 | RJ26FW105 | RJ26FX105 | RJR26FP105* | RJR26FW105* | RJR26FX105* |

*LAST LETTER IN NUMBER IS FAILURE RATE LEVEL. M = 1.0% P = 0.1% R = 0.01%

HOW TO USE THIS SECTION

This Applications/Processing Guide is intended to provide you with points to consider for designing circuits, selecting trimmers and arranging board layouts, to achieve maximum performance and long life for your circuits and systems. We have also included information on steps your manufacturing engineers can take to preserve circuit reliability.

For example, are you aware that the trimmers and other mechanical components on your boards may face a more extreme environment during boardwashing on your own production line, than they ever will in use? For those trimmers that may need to be reset, are you remembering to select and mount the trimmers to provide easy accessibility?

In this section, you'll find dozens of pointers, reminders and useful facts that will help you be more knowledgeable and successful in using trimmers.

TRIMMER BASICS

In its most common form, a trimmer is simply a device containing a resistive element, and a wiper, or adjustable tap, contacting the element. The wiper can be mechanically moved to vary the amount of voltage or resistance in the circuit. The resistive element is usually laid out in linear or a circular configuration:

The Resistive Element

Trimmers for commercial applications typically have a resistive element made of carbon or cermet (a combination of CERamic and METal), or of resistance wire wound on an insulated copper mandrel.

The main advantages of wirewound trimmers are their low temperature coefficient, higher power dissipation, lower noise, tighter resistance tolerance, and, when used as a variable resistor, the excellent current-carrying capacity through the wiper due to the lower contact resistance. Also, their long-term resistance stability with time and temperature is slightly better than cermet.

Cermet trimmers provide a wider resistance range (10 ohms to 5 megohms, versus a maximum of 50K ohms for wirewound). Also, the wiper output can be set closer to the desired value since the resistive element presents a continuous contact surface for the wiper, as opposed to the discrete turns (resolution) of the wirewound. Other advantages with cermet are the lower reactance in high-frequency applications, the smaller sizes available, and the generally lower price than wirewound types.

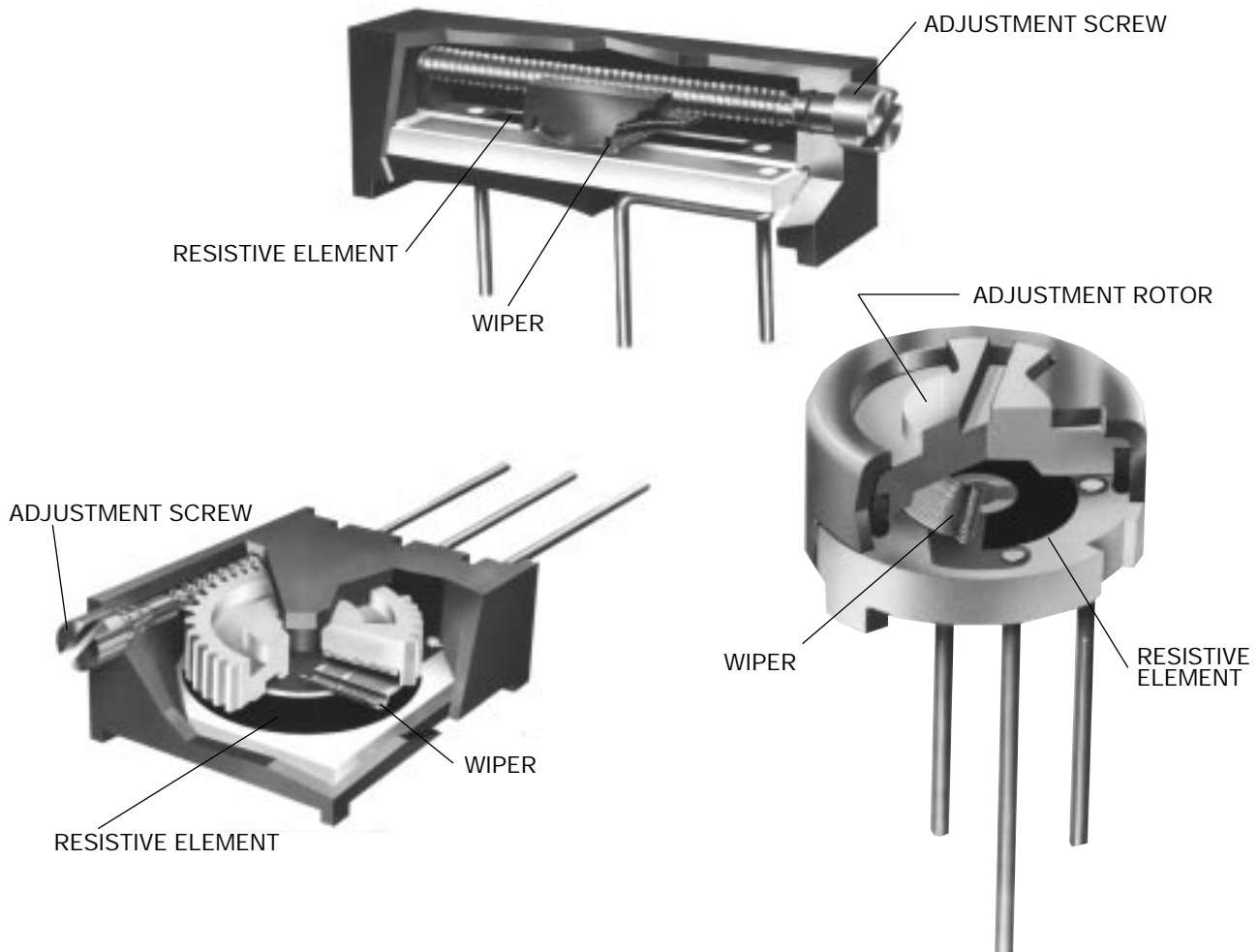

This application note is designed to provide step-by-step processing recommendations. It covers the popular SMC soldering processes currently in use and provides recommendations and cautions for each step. Since many variations of temperature, time, processes, cleaning agents and board types are found in the electronics industry, you'll want to test and verify your own system.

The process steps, recommendations and cautions are based on Bourns Trimpot surveys of SMC users, equipment manufacturers and materials suppliers. Also, comments reflect results of Bourns' testing. Our findings suggest the following soldering and cleaning processes:

1. SOLDERING - Forced Hot Air, Convection, IR, Vapor Phase (In-Line), Wave (Single and Dual)
 2. CLEANING - Solvent, Aqueous, Semi-Aqueous, No-Clean
- On the facing page are the common methods, materials and maximum temperature/time parameters for soldering and cleaning processes.

1

Solder Paste Printing

Reflow

GENERAL

Use the optimum solder paste for the pattern, printing process, solder paste density and solder joint quality.

RECOMMENDED

Use Sn 63% Pb 37% solder paste. Use 8 to 10 mil thickness for solder paste print.

CAUTION

Since solder paste usually contains a high percentage of activators, you must ensure adequate cleaning to remove all residues, unless no-clean (low solids) paste is used.

2

Adhesive Application

Flow (Wave)

GENERAL

The adhesive must hold the SM Component (SMC) in correct orientation upon placement and maintain correct trimmer position during physical handling before final solder processing.

RECOMMENDED

To assure positional stability, place a single dot of epoxy under the SMC.

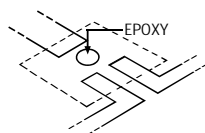

CAUTION

Stability after placement is a direct function of the volume of adhesive used. Use enough epoxy to assure stability through the cure process.

Avoid overflow of epoxy to solder pad and terminal areas.

3

SMC Placement

GENERAL

Use pick-and-place equipment with vacuum nozzle ID size that allows adequate suction to pick the SMC out of the embossed cavity.

RECOMMENDED

The nozzle inside diameter (ID) should not exceed .100 in. (2.54mm) to ensure adequate suction and part alignment.

CAUTION

Assure parts are placed so that all terminals are equidistant (<4 mils) from the solder pads.

Align terminals with solder belt direction of travel to avoid body shadowing effects during flow soldering.

4

Adhesive Cure

Flow (Wave)

GENERAL

Use heat/time cure method with either convection oven or infrared radiation.

RECOMMENDED

Cure using the temperature and times recommended by the adhesive manufacturer.

CAUTION

Use enough cure time to assure complete adhesive transition from fluid to solid.

5

Flux Application

Flow (Wave)

GENERAL

Use the correct flux to remove surface oxides, prevent reoxidation and promote wetting.

RECOMMENDED

- RMA
- No-clean SRB (Synthetic resin based)
- OA (Organic Acid) (See caution)

CAUTION

Avoid highly activated fluxes. Consult factory before using OA.

SOLDERING/CLEANING METHODS

| Process Step | REFLOW | | | | | | | | FLOW | | | | Material |
|-----------------------------|-----------------------------|-----------------------------|-----------------------------|------------------------------|-----------------------|-----------------------|-----------------------|------------------------|----------------|----------------|----------------|-----------------|--------------------------------|
| | Hot Air; Infrared (Solvent) | Hot Air; Infrared (Semi-Aq) | Hot Air; Infrared (Aqueous) | Hot Air; Infrared (No-Clean) | Vapor Phase (Solvent) | Vapor Phase (Semi-Aq) | Vapor Phase (Aqueous) | Vapor Phase (No-Clean) | Wave (Solvent) | Wave (Semi-Aq) | Wave (Aqueous) | Wave (No-Clean) | |
| 1. Solder Paste Printing | X | X | X | X | X | X | X | X | | | | | |
| 2. Adhesive Application | | | | | | | | | X | X | X | X | |
| 3. Component Placement | X | X | X | X | X | X | X | X | X | X | X | X | |
| 4. Adhesive Cure | | | | | | | | | X | X | X | X | |
| 5. Flux Application | | | | | | | | | X | | | | Rosin |
| 5. Flux Application | | | | | | | | | | X | | | Rosin |
| 5. Flux Application | | | | | | | | | | | X | | Organic Acid |
| 5. Flux Application | | | | | | | | | | | | X | Synthetic Resin Based |
| 6. Solder (Reflow) | X | X | | X | X | X | X | X | | | | | 63/37 Sn/Pb |
| 7. Solder (Flow) | | | | | | | | | X | X | X | X | 63/37 Sn/Pb |
| 8. Wash (Solvent) | X | | | | X | | | | X | | | | ODS Free |
| 8. Wash (Semi-Aqueous) | | X | | | | X | | | | X | | | Terpene, Hydrocarbon Based |
| 8. Wash (Aqueous) | | | X | | | X | | | | | X | | DI H2O; Surfactant; Saponifier |
| High Pressure Fluids | | | X | | | X | | | | | X | | (See Caution) |
| Max. Temp. (°C)/Time (Secs) | 235/40 | 235/40 | 235/40 | 235/40 | 215/180 | 215/180 | 215/180 | 215/180 | 260/5 | 260/5 | 260/5 | | |
| Min. Temp. (°C) | 215 | 215 | 215 | 215 | 215 | 215 | 215 | 215 | 215 | 215 | 215 | | |

TRIMMING POTENTIOMETERS AND DEFINITIONS

The following terms and definitions have been edited from the Industrial Standard published by the Variable Resistive Components Institute. It is intended to encourage standardization in communication and understanding between the manufacturer and user. The complete standard, including detailed test procedures, is available upon request.

GENERAL TERMS

TRIMMING POTENTIOMETER: An electrical mechanical device with three terminals. Two terminals are connected to the ends of a resistive element and one terminal is connected to a movable conductive contact which slides over the element, thus allowing the input voltage to be divided as a function of the mechanical input. It can function as either a voltage divider or rheostat.

WIREWOUND TRIMMING POTENTIOMETER: A trimming potentiometer characterized by a resistance element made up of turns of wire on which the wiper contacts only a small portion of each turn.

NON-WIREWOUND TRIMMING POTENTIOMETER: A trimming potentiometer characterized by the continuous nature of the surface area of the resistance element to be contacted. Contact is maintained over a continuous, unbroken path. The resistance is achieved by using material compositions other than wire such as carbon, conductive plastics, metal film and cermet.

RESISTANCE ELEMENT: A continuous, unbroken length of resistive material without joints, bonds or welds except at the junction of the element and the electrical terminals connected to each end of the element, or at an intermediate point such as a center tap.

ADJUSTMENT SHAFT: The mechanical input member of a trimming potentiometer which when actuated causes the wiper to traverse the resistance element resulting in a change in output voltage or resistance.

SINGLE-TURN ADJUSTMENT: Requires 360° or less mechanical input to cause the wiper to traverse the total resistance element.

MULTITURN ADJUSTMENT: Requires more than 360° mechanical adjustment to cause the wiper to traverse the total resistance element.

TERMINAL: An external member that provides electrical access to the resistance element and wiper.

LEADWIRE TYPE TERMINAL: Flexible insulated conductor.

PRINTED CIRCUIT TERMINAL: Rigid uninsulated electrical conductor, suitable for printed circuit board plug-in.

SOLDER LUG TERMINAL: Rigid uninsulated electrical conductor, suitable for external lead attachment.

WIPER: The wiper is the member in contact with the resistive element that allows the output to be varied when the adjustment shaft is rotated.

STOP-CLUTCH: A device which allows the wiper to idle at the ends of the resistive element without damage as the adjustment shaft continues to be actuated in the same direction.

STOP – SOLID: A positive limit to mechanical and/or electrical adjustment.

STACKING: The mounting of one trimming potentiometer adjacent to or on top of another utilizing the same mounting hardware.

THEORETICAL RESOLUTION: (Wirewound only) The theoretical measurement of sensitivity to which the output ratio may be adjusted; the reciprocal of the number of turns of wire in resistance winding expressed as a percentage.

N = Total number of resistance wire turns.

$\frac{1}{N} \times 100$ = Theoretical resolution percent.

INPUT AND OUTPUT TERMS

TOTAL APPLIED VOLTAGE: The total voltage applied between the designated input terminals.

OUTPUT VOLTAGE: The voltage between the wiper terminal and the designated reference point. Unless otherwise specified, the designated reference point is the CCW terminal.

OUTPUT RATIO: The ratio of the output voltage to the designated input reference voltage. Unless otherwise specified, the reference voltage is the total applied voltage.

LOAD RESISTANCE: An external resistance as seen by the Output Voltage (connected between the wiper terminal and the designated reference point.)

ADJUSTMENT TERMS

DIRECTION OF TRAVEL: Clockwise (CW) or counterclockwise (CCW) rotation when viewing the adjustment end of the potentiometer.

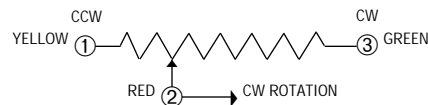

MECHANICAL TRAVEL — SOLID STOPS: The total travel of the adjustment shaft between integral stops. Continuity must be maintained throughout the travel.

MECHANICAL TRAVEL — CLUTCHING ACTION: The total travel of the adjustment shaft between the points where clutch actuation begins. Continuity must be maintained throughout the travel and during clutch actuation.

MECHANICAL TRAVEL — CONTINUOUS ROTATION: The total travel of the adjustment shaft when the wiper movement is unrestricted at either end of the resistive element as the adjustment shaft continues to be actuated.

ADJUSTMENT TRAVEL (ELECTRICAL): The total travel of the adjustment shaft between minimum and maximum output voltages.

CONTINUITY TRAVEL: The total travel of the shaft over which electrical continuity is maintained between the wiper and the resistance element.

ELECTRICAL AND OPERATIONAL CHARACTERISTICS

TOTAL RESISTANCE: The DC resistance between the input terminals with the wiper positioned to either end stop, or in dead band for continuous rotation potentiometers.

TEST VOLTAGE

| Total Resistance, Nominal | Maximum Test Voltage | |
|---------------------------|----------------------|-----------|
| | Non-Wirewound | Wirewound |
| Ohms | Volts DC | Volts DC |
| .1 TO 1.0 | 0.1 | 0.1 |
| 1.0 to 50 | 0.3 | 0.3 |
| 50 to 100 | 2.0 | 2.0 |
| 100 to 1000 | 3.0 | 3.0 |
| 1K to 100K | 10 | 10 |
| Over 0.1 megohm | 50 | — |

NOTE: The test voltages should never exceed the equivalent of 10% rated power. The minimum voltage to be used is 10 MV.

ABSOLUTE MINIMUM RESISTANCE: The resistance measured between the wiper terminal and each end terminal with the wiper positioned to give a minimum value.

END RESISTANCE: The resistance measured between the wiper terminal and an end terminal when the wiper is positioned at the corresponding end of mechanical travel. Absolute minimum resistance and end resistance are synonymous for continuous rotation trimmers.

TEMPERATURE COEFFICIENT OF RESISTANCE: The unit change in resistance per degree Celsius change from a reference temperature, expressed in parts per million per degree Celsius as follows:

$$TC = \frac{R^2 - R^1}{R^1 (T^2 - T^1)} \times 10^6$$

Where:

- R1 = Resistance at reference temperature in ohms.
- R2 = Resistance at test temperature in ohms.
- T1 = Reference temperature in degrees Celsius.
- T2 = Test temperature in degrees Celsius.

RESISTANCE-TEMPERATURE CHARACTERISTIC: The difference between the total resistance values measured at a reference temperature of 25°C and the specified test temperature expressed as a percent of the Total Resistance.

$$RTC = \frac{R^2 - R^1}{R^1} \times 100$$

Where:

- R1 = Resistance at reference temperature (25°C) in ohms.
- R2 = Resistance at the test temperature in ohms.

CONTACT RESISTANCE VARIATION: The apparent resistance seen between the wiper and the resistance element when the wiper is energized with a specified current and moved over the adjustment travel in either direction at a constant speed. The output variations are measured over a specified frequency bandwidth, exclusive of the effects due to roll-on or roll-off of the terminations and is expressed in ohms or % of total resistance.

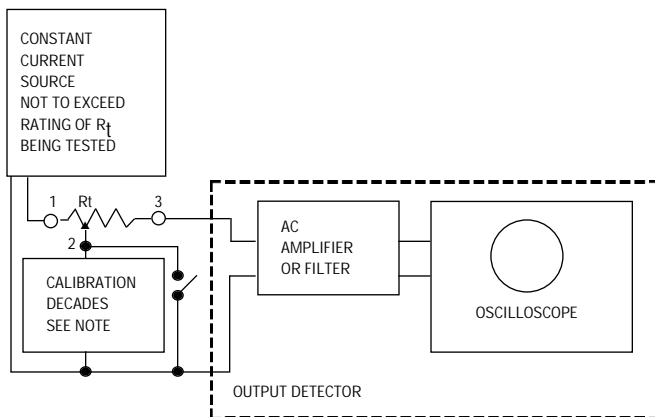

Figure 1. Contact-resistance-variation measuring circuit

- Rt = Test specimen
- Output detector bandwidth: 100 cycles to 50 kilocycles
- Minimum input impedance to output detector:
- At least 10 times the nominal resistance being tested

NOTE: At the calibration of the decade, terminals 1 and 2 must be coincident. Calibration decade is to be set for the contact-resistance variation (CRV) level of the specified nominal resistance being tested.

TABLE II

| Test Current ($\pm 20\%$) | Total Resistance Range |
|-----------------------------|---|
| 30 ma | $2 = R_t = 200$ |
| 5 ma | $200 < R_t = 3K$ |
| 1 ma | $3K < R_t = 200K$ |
| 200 ua | $200K < R_t = 1 \text{ megohm}$ |
| 50 ua | $1 \text{ megohm} < R_t = 5 \text{ megohm}$ |

EQUIVALENT NOISE RESISTANCE: Wirewound only. Any spurious variation in the electrical output not present in the input, defined quantitatively in terms of an equivalent parasitic, transient resistance in ohms, appearing between the contact and the resistive element when the shaft is rotated. The equivalent Noise Resistance is defined independently of the resolution, functional characteristics and the total travel. The magnitude of the Equivalent Noise Resistance is the maximum departure from a specific reference line. The wiper of the potentiometer is required to be excited by a specific current and moved at a specific speed.

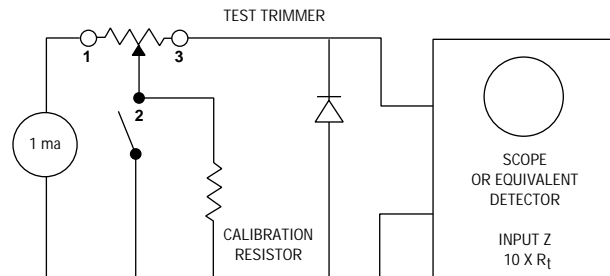

$$ENR \text{ (ohms)} = \frac{\text{Max. deviation (volts)}}{.001 \text{ amps}}$$

CONTINUITY: Continuity is the maintenance of continuous electrical contact between the wiper and both end terminals of the resistive element.

SETTING STABILITY: The amount of change in the output voltage, without readjustment, expressed as a percentage of the total applied voltage.

DIELECTRIC STRENGTH: The ability to withstand the application of a specified potential of a given characteristic, between the terminals and all other external conducting members such as shaft, housing and mounting hardware without exceeding a specified leakage current value.

INSULATION RESISTANCE: The resistance to a specified DC voltage impressed between the terminals and all other external conducting members such as shaft, housing and mounting hardware.

POWER RATING: The maximum power that a trimming potentiometer can dissipate across the total resistive element under specified conditions while meeting specified performance requirements.

ROTATIONAL LIFE: The number of cycles obtainable under specified operating conditions while remaining within specified allowable degradation. A cycle is defined as one complete traversal of the wiper over the resistive element in both directions.

LOAD LIFE: The number of hours at which a device may dissipate rated power under specified operating conditions while remaining within specified allowable degradations.

ADJUSTABILITY (OUTPUT RESISTANCE): The precision with which the output resistance of a device can be set to the desired value.

ADJUSTABILITY (OUTPUT VOLTAGE RATIO): The precision with which the output voltage ratio of a device can be set to the desired value.

MECHANICAL TERMS

STARTING TORQUE: The maximum moment in the clockwise and counterclockwise directions required to initiate shaft adjustment anywhere in the mechanical travel.

STOP TORQUE: The maximum static moment that can be applied to adjustment shaft at each mechanical stop for a specified period of time without loss of continuity or mechanical damage affecting operational characteristics.

SOLDERABILITY: The ability of the terminals to accept a uniform coating of solder under specified conditions.

WELDABILITY: The ability of materials to be welded together under specified conditions.

TERMINAL STRENGTH: The ability of the terminals to withstand specified mechanical stresses without sustaining damage that would affect utility of the terminals or operation of the trimming potentiometer.

IMMERSION SEALED: The ability of the unit to withstand submersion in acceptable cleaning solutions used in normal soldering processes without performance degradation under specified environmental conditions.

TRIMMER "ABILITIES"

When you are selecting components for a new design, you typically take into account the environmental conditions that the components will need to endure during the lifetime of the instrument or device. Designers in the past have often overlooked the environmental extremes of their own production lines, where the conditions may be much more severe than anything encountered in actual end use.

PROCESSABILITY

"Processability" refers to the ability of the unit to withstand the production-line processes associated with the finishing steps on the PC boards. Typically, both SMT and through-hole products are subjected to similar PC board processing operations after preparation for assembly. These operations can generally be summarized as follows:

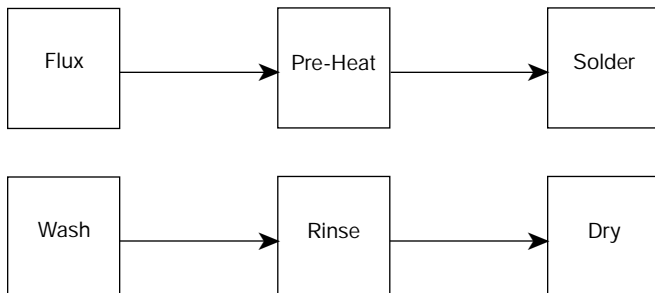

Soldering (SMT)

Four types of equipment are usually associated with SMT soldering:

IR System — Uses a multi-zone infrared furnace with IR elements heated to a temperature substantially above chamber or product temperature. Energy is supplied to the product primarily by IR radiation to reflow solder.

Forced Hot Air Convection System — Uses a multizone forced air convection system with heat source panels using IR or other type heating elements. Approximately 85% of the heating is provided by free convection to reflow solder on exposed PC boards.

Dual Wave System — Utilizes two parallel solder waves. The first is a turbulent wave followed by a laminar wave. The turbulent wave is for small, constricted areas, while the laminar wave removes solder projections.

Vapor Phase System — Provides a single-zone condensation heat source achieved with liquid fluorinated hydrocarbons that have been brought to the boiling point to create a saturated vapor zone. Heat is then released by the fluid's heat of vaporization as the vapor condenses on the product.

Soldering (Through-hole)

Two types of equipment are usually associated with through-hole soldering:

Single Wave System — Provides an inclined portion of the solder wave for the PC board to pass over. The PC board is positioned to bring many potential solder joints in contact with the wave simultaneously for a short time for soldering.

Drag System — Provides for PC boards to be dragged across the surface of the solder pot. Soldered connections are made during this operation.

PC Board Washing

Two types of equipment are usually associated with both SMT and through-hole products.

Pressure System — Accomplishes cleaning by directing sprays of water under high pressure from multiple nozzles.

Flooding System — Utilizes a combination of flooding (at normal water pressure) and surfactant action for cleaning).

Soldering and Wash Processes

Figure 1 shows typical profiles any component may see during a soldering and board washing operation. For details of material and process variables recommendations, see "Soldering and Cleaning Processes", page 76.

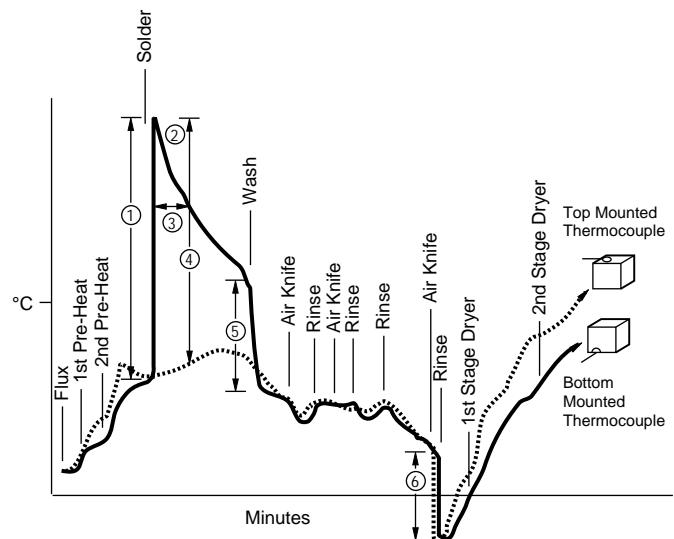

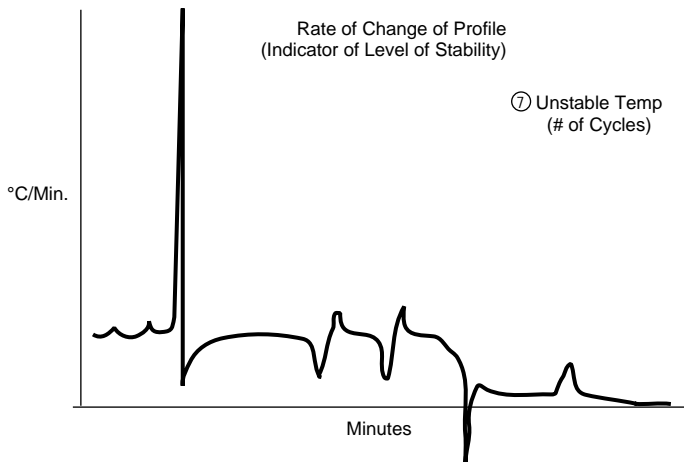

Figure 1.
Typical temperature profile for board washing and soldering.

Critical profile parameters

- ① Temperature Shock (°C)
- ② Maximum Temperature (°C)
- ③ Temperature Exposure (Minimum)
- ④ Temperature Gradient (°C)
- ⑤ Temperature Shock Decrease in Water (°C)
- ⑥ Temperature Shock Decrease in Water & Air Pressure (°C)
- ⑦ Unstable Temperature (see next page)

General Guidelines for Guarding Against Component Damage

- To minimize temperature shock
 - Pre-heat boards to maximum acceptable level
 - Reduce time in solder
- To avoid heating components above their maximum rated temperature
 - Use lowest acceptable solder temperature
 - Use maximum allowable conveyor speed
 - Limit pre-heat temperature to maximum necessary
- To limit time of exposure above rated temperature
 - Limit time in solder
 - After solder operation, cool board to wash temperature before it enters wash
- To minimize temperature difference between top and bottom of board
 - Apply pre-heat to both top and bottom
- To reduce temperature shock on entering the moist environment of the wash
 - Use wash/rinse temperature as near component temperature as possible
 - Extend time between solder process and wash
 - Cool board after solder operation, prior to entering wash
- To minimize temperature variations as component travels through moisture
 - Minimize number of wash/rinse and rinse/dry cycles
 - Use heated air for air knives (to counter evaporative cooling effect)
 - Minimize difference between wash and rinse temperature

To minimize exposure to high-pressure water during board wash

- Select trimmer models with pin styles that orient the rotor seal area away from exposure to the high-pressure water stream

SETTABILITY

Settability refers to the ease with which a trimmer can be set accurately to the position that produces the desired circuit condition.

Where the requirement is for obtaining a highly accurate setting the preference is for cermet — because a small incremental adjustment in a wirewound unit does not always produce the expected change in output as the wiper moves off one turn of wire and onto another.

Setting accuracy is better with a multiturn unit than with a single-turn. This is especially true when the speed of setting is also a requirement as on a production line (Figure 2).

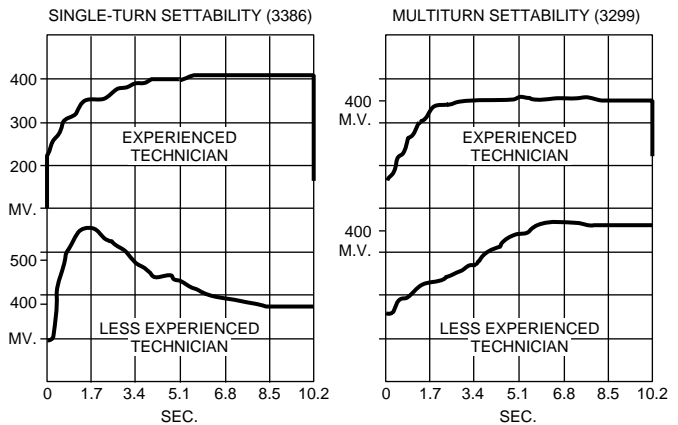

Figure 2.
When accurate setting is required, a multiturn trimmer can generally be set faster than a single-turn.

STABILITY

Stability refers to the ability of the trimmer to remain at the desired setting. Environmental factors play an important role here: stability may be affected by temperature exposure, thermal shock/cycling, humidity, and mechanical shock or vibration.

This is not a matter of concern in most applications, since Bourns trimmers exhibit excellent stability under all specified conditions. Stability is most often a concern when cermet trimmers are used in low current "dry" circuits (50uA amps and below). Under these conditions the contact resistance may vary, making the wiper appear unstable. This is most noticeable in some rheostat applications. This can be avoided by using a wirewound unit, or choosing a cermet trimmer that has been designed for dry-circuit applications. Bourns applications engineers can assist you on this and other questions.

ACCESSIBILITY

When selecting a trimmer and determining its placement on the board, keep in mind the people who will have to use it. Bourns trimmers are available in a wide variety of sizes, shapes, configurations, and placement of adjustment screws. You will usually find a unit on which the access for adjustment will be convenient for the user.

Keep in mind the different requirements for accessibility depending on whether adjustment will be done on the assembly line or in the field; with the board uncovered, in a housing or cabinet, or on an extender. Also consider whether production-line adjustment will be done manually or by robotics. A Bourns applications engineer can advise on special high-speed automatic adjustment features.

USABILITY

In selecting a trimmer for a specific application, it's important to be aware that the catalog contains a myriad of facts about each model that can assist you in finding the most suitable choice. For example:

Contact Resistance Variation (CRV) — Under MIL-R 22097 and MIL-R-39035, the maximum CRV is 3%. All Bourns trimmers meet this standard (3% or 3 ohms, whichever is greater). For applications that demand a more rigorous standard, some Bourns trimmers are rated at 2% or 2 ohms, and many others at 1% or 1 ohm.

Power Rating — The ambient temperature at which the trimmer will operate has an important bearing on power rating. Power ratings are usually specified at 70° or 85°C; at a temperature of 150°C, the power rating of many trimmers is reduced to zero.

Temperature Coefficient of Resistance (T.C.) — This specification is a measure of how much the resistance changes with a change in temperature. In many applications a T.C. of $\pm 250\text{PPM}/^\circ\text{C}$ is acceptable. Typical T.C. specifications for cermet models are $\pm 100\text{PPM}/^\circ\text{C}$ and $\pm 50\text{PPM}/^\circ\text{C}$ for wirewound models.

RELIABILITY

One of the greatest challenges facing American manufacturers in the early '90s lies in the area of reliability — a challenge for component manufacturers and equipment manufacturers alike. Bourns has been on the leading edge of this effort, both in the area of instituting new methods and technologies for achieving higher reliability, and bringing an awareness of the need to other manufacturers.

SURFACE MOUNTED DEVICES (SMD)

AN EMERGING TECHNOLOGY

Surface mounting of electronic components represents another significant advance in PC board processing. Many U.S. companies have expressed an interest in SMD assembly methods to replace the often troublesome and costly techniques now used with leaded components. Unfortunately, for a number of reasons, this interest has not resulted to date in a major commitment to SMD handling equipment.

There are direct and indirect benefits associated with surface mounting. Since the direct benefits are outgrowths of the indirect ones, some explanation of these interrelated factors is required in order to understand this complex, highly technical and investment intensive subject. Further, a listing of the primary advantages will make additional comments on Japan's SMD usage and growth unnecessary.

In capsule format, the primary advantages (with comments on secondary benefits) are:

- **Lower End-Equipment Cost**
(positions OEM's for aggressive pricing to achieve market penetration).
- **Superior Product Performance**
(satisfies user requirements for improved operational performance).
- **Improved Product Quality and Reliability**
(creates confidence factor which easily translates to increased demand or sales).

- **Smaller Finished Product Size**

(addresses demand for miniaturization).

Cost, performance, quality/reliability and size — how are these factors interrelated and how are they achieved through surface mounting?

A by-product of SMD technology is the downsizing of components. Size reductions range from 25% to 60%, depending upon the device in question. High PC board densities can be achieved (more components per square inch of real estate; surface mounted units can also be assembled on both sides). PC board material savings alone are substantial. When circuits diminish, external hardware and other materials follow — further savings. Even freight charges are decreased by lighter equipment weight and less packaging.

Surface mounted component prices are forecasted to decline, the result of automated volume production. Volume is directly related to component standardization. By having a few sizes to cover a large range of electrical values and/or parameters, large quantities of a given device can be produced at a much lower per unit cost. Selling prices fall as volume increases. Component quality is also enhanced by eliminating many of the variables associated with short production runs.

Automatic SMD handling equipment, although capital intensive, is the single-most effective way to reduce labor costs and increase yields. Typical "pick and place" machines can assemble components 8 to 10 times faster than human assemblers, with virtually no mistakes. Major direct labor reductions are obvious. The combination of improved component quality and "mistake-free" component placement further decreases costs by eliminating the normal rework of auto-inserted boards.

The many advantages of SMD technology will force change upon both electronic equipment manufacturers and component suppliers alike. Worldwide competitive prices and performance pressures will make it happen. Few electronic components will escape its influence, trimming potentiometers being no exception. Bourns is committed to SMD conversion, and we intend to be a leader in surface mounted trimmer devices. Bourns surface mount trimmers begin on page 12.

GENERAL NOTES:

Plated-Through Holes: (Ref. MIL-STD-275D).

- 5.5 Plated-through holes. The difference between the inside diameter of the plated-through hole and the nominal outside diameter of the inserted lead shall be not greater than 0.028 inch (0.71mm) or less than 0.010 inch (0.25 mm). Unless otherwise specified, the hole size shall be the finished plated size after solder coating or fusing. When flat ribbon leads are mounted through plated-through holes, the difference between the nominal thickness of the lead and the inside diameter of the plated-through hole shall not exceed 0.028 inch (0.71 mm).